

Assemble Me. Drive Me

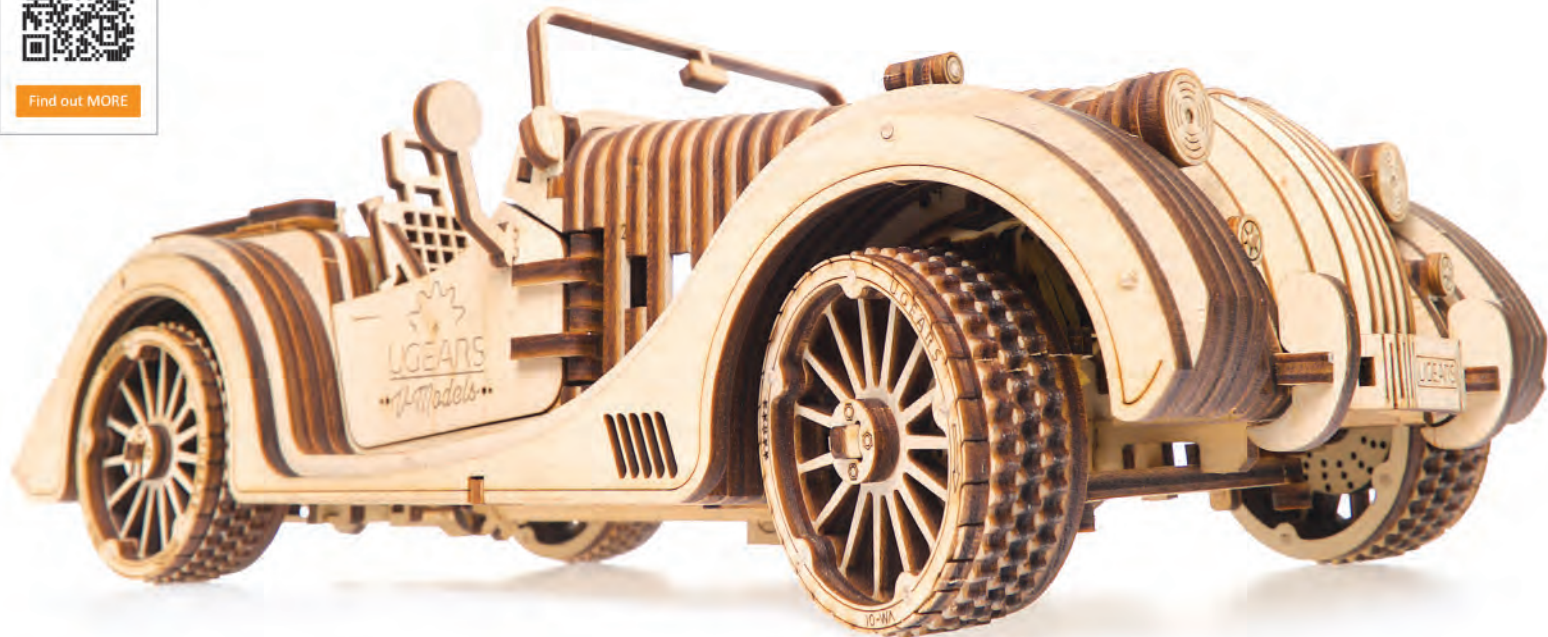

Find out MORE



UGEAR'S®
U-Models™

Model «Roadster VM-01»
Модель «Родстер VM-01»

DEU Modell «Roadster VM-01». FRA Modèle «Roadster VM-01».
POL Model «Roadster VM-01». SPA Modelo «Roadster VM-01».
ITA Modello «Roadster VM-01». RUS Модель «Родстер VM-01».
JAP ロードスター VM-01. KOR 로드스터 VM-01.
CHI 敞篷跑车 VM-01.

Assembly instructions
Інструкція зі складання

DEU Aufbauanleitung. FRA Notice d'assemblage.
POL Instrukcja montażu. SPA Instrucciones de montaje.
ITA Istruzioni di montaggio. RUS Инструкция по сборке.
JAP 組み立て説明書 KOR 조립 설명서.
CHI 装配说明书



NATURAL
Made from wood materials



NO GLUE CONNECTION
Assembling without glue and chemicals



SELF ASSEMBLY
Details are already cut and ready to assemble



MECHANICAL
The models produce motion



EDUCATIONAL
Perfect for family projects through hands-on STEM learning

Mechanical models

ENG

Assembly instructions:
Remove model parts from the hanger board as illustrated below. Careful not to break parts. If a part does not remove easily, carefully cut it out with a knife. This model is intended for self-assembly without glue. If you have difficulty installing the axles, try waxing them with a regular candle. All moving parts can also be waxed during assembly to reduce friction when operating the model.

UKR

Інструкція зі складання:
Витягніть з дошки позначені на схемі деталі. Намагайтеся їх не зламати. Якщо деталь не виймається, надсічть перемички ножом. Конструкція збирається без клею. У разі виникнення труднощів з протягуванням зубочистки (вісі) в отвір, потріть зубочистку об звичайну свічку. Також можна змастити свічкою всі деталі механізму, що рухаються, щоб зменшити тертя при обертанні.

DEU

Aufbauanleitung:
Bitte die in der Zeichnung angegebenen Teile aus der Platte herausnehmen. Versuchen Sie bitte diese nicht zu brechen. Wenn sich ein Teil nicht herausnehmen lässt, schneiden Sie die Stege mit dem Messer leicht an. Das Modell wird ohne Klebstoffe zusammengebaut. Lässt sich eine Achse nur schwer in eine Öffnung einführen, reiben Sie diese mit einer Kerze etwas ein. Für besseres Gleiten schmieren Sie alle beweglichen Teile mit einer Kerze.

FRA

Notice d'assemblage:
Faites sortir de la planche les pièces comme indiquées sur le schéma. Tâchez de ne pas les casser. Si la pièce ne sort pas, incisez les collages/fixations avec un couteau. La construction est à assembler sans colle. Si il est difficile d'introduire l'axe en bois dans l'orifice, frottez au préalable l'axe ou les pièces contre une bougie. Pour améliorer le glissement, traitez les pièces de frottement mobiles du mécanisme avec une bougie au cours d'assemblage.

POL

Instrukcja montażu:
Delikatnie wyciągaj z deseczeki wskazane w schemacie detale, starając się nie połamać elementów. Jeśli detal nie poddaje się, podetnij wiązadła nożem. Konstrukcję składa się bez kleju. Jeśli napotkasz trudności z instalacją drewnianej osi w otwór, potrzyj na początku oś lub detale o woskową świecę. Dla lepszego poślizgu polecano smarowanie ruchomych części mechanizmu zwykłą świecą podczas montażu.

SPA

Instrucciones de montaje:
Saque de la tabla las piezas marcadas en el esquema. Trate de no romperlas. Si una pieza no se saca, haga una incisión. La construcción va sin pegamento. Si tiene dificultades con la instalación del eje de madera en un agujero, frote primero el eje o las piezas contra una vela. Para un mejor deslizamiento, lubrique durante el montaje las piezas móviles del mecanismo con una vela común.

ITA

Istruzioni di montaggio:
Estrarre dal telaio i particolari indicati nello schema. Fare attenzione a non romperli. Se un particolare non si stacca, tagliare delicatamente gli elementi di collegamento con un coltello. L'assieme viene realizzato senza colla. In caso di difficoltà nell'inserimento di un perno in legno, è necessario sfregare il perno o il particolare con un po' di cera. Per uno scorrimento migliore incerare le parti mobili del meccanismo durante l'assemblaggio.

RUS

Инструкция по сборке:
Вынимайте из доски обозначенные на схеме детали. Старайтесь их не сломать. Если деталь не извлекается, надрежьте перемычки ножом. Конструкция собирается без клея. Если возникли трудности с установкой движущей оси, перед установкой потрите детали об обычную свечу. Для лучшего скольжения смазывайте движущиеся детали механизма обычной свечой во время сборки.

JAP

組み立て説明書:
部品に傷をつけないよう注意しながらボードから外してください。部品が外れにくい場合は連結部分をカッターで切ってから外すと外しやすいです。本製品は、接着剤がなくても組み立てができるように設計されています。もしアクスル(駆動部)が、歯車の動きがにぶい場合は、口ウソクをアクスルに塗ってください。全ての駆動部分は製品を動かす時、滑らかに動くように潤滑剤である口ウソクを塗りながら組み立てます。

KOR

조립 설명:
부품이 손상되지 않도록 주의하여 보드에서 떼어냅니다. 만약 부품이 잘 떨어지지 않으면 연결 부분을 칼로 잘단 한 후 떼어내면 쉽게 떼어 낼 수 있습니다. 본 제품은 접착제가 없이 조립이 가능하도록 설계되어 있습니다. 만약 축이 잘 끼워지지 않는 경우 양초를 축에 바른 후 끼워보세요. 모든 구동 부위는 제품 구동 시 원활한 작동이 가능하도록 조립 과정에서 윤활제(양초)양초를 발라 주세요.

CHI

装配说明
将模型部件按插图所示,从胶合板取下。小心不要损坏件。如果取下时候有难度,请用小刀小心地切割连接点。这个产品不需要胶水粘接。如果安装转轴的时候有难度,请用普通的蜡加以润滑。所有的转动部分也需要打蜡润滑。

ENG Warning! **UKR** Увага! **DEU** Achtung! **FRA** Attention! **POL** Uwaga! **SPA** Precaución!
ITA Attenzione! **RUS** Внимание! **JAP** 注意! **KOR** 주의! **CHI** 注意!



ENG Do not use a lighted candle! **UKR** Не підпалювати! **DEU** Nicht anzünden!
FRA Ne pas brûler! **POL** Nie podpalać! **SPA** ¡No encender! **ITA** Non dare fuoco!
RUS Не поджигать! **JAP** 火のついた口ウソクの使用はお止めください。
KOR 불이 붙은 초를 이용하지 마세요! **CHI** 请勿点燃, 请勿靠近火源!



ENG Caution! Axles have sharp points! **UKR** Обережно! Гострі деталі!
DEU Vorsicht! Spitze Teile! **FRA** Attention: certaines pièces sont pointues!
POL Ostrożnie! Ostre części! **SPA** ¡Atención! Piezas afiladas! **ITA** Attenzione! Particolari appuntiti! **RUS** Осторожно! Острые детали! **JAP** アクスル(駆動部)の鋭い部分にご注意ください。
KOR 축의 뾰족한 부분에 주의하세요!
CHI 注意! 含尖锐部件

ENG Customer support **UKR** Служба підтримки **DEU** Kundendienst **FRA** Service client **POL** Wsparcie klienta
SPA Servicio al cliente **ITA** Servizio di supporto **RUS** Служба поддержки **JAP** お客様窓口 **KOR** 고객센터 **CHI** 客户支持

customerservice@ugearsmodels.com

ENG Symbols. UKR Умовні позначення. DEU Legende. FRA Légende. POL Oznaczenia umowne.
 SPA Leyenda. ITA Legenda. RUS Условные обозначения. JAP 記号 KOR 기호. CHI 图标含义



ENG Wax the part with a regular candle (rub with a candle). UKR Змастіть деталь звичайною свічкою (потріть об свічку). DEU Reiben Sie das Teil mit einer einfachen Kerze etwas ein. FRA Lubrifiez la pièce avec une bougie ordinaire (frottez contre la bougie). POL Przesmaruj zwykłą świecą. SPA Engrase la pieza con una vela común (frote con una vela). ITA Incerare il componente (Sfregare con la cera). RUS Смажьте деталь обычной свечкой (потрите о свечку). JAP 表示された部分に潤滑剤としてロウソクを塗ってください。KOR 표시된 부분에 윤활을 위해 초를 칠해 주세요. CHI 用普通蜡烛涂抹润滑部件。



ENG Pay attention. Check for correct orientation or positioning. UKR Зверніть увагу. Перевірте розташування елемента. DEU Bitte Beachten. Prüfen Sie die Einbaulage des Elementes. FRA Faites attention. Vérifiez la disposition de l'élément. POL Zwróć uwagę. Sprawdź lokalizację elementu. SPA Atención. Compruebe la situación del elemento. ITA Prestare attenzione. Controllare la posizione del componente. RUS Обратите внимание. Проверьте расположение элемента. JAP 方向及び位置に注意して組み立ててください。KOR 방향 또는 위치에 주의해서 조립해 주세요. CHI 注意！检查部件方向和位置



ENG The part should be easily rotated (moved). UKR Деталь повинна легко крутитися (рухатися). DEU Der Teil soll leicht gedreht (bewegt) werden. FRA La pièce doit tourner (se déplacer) aisément. POL Element powinien łatwo się kręcić (poruszać się). SPA La pieza debe ser fácil de girar (mover). ITA Il componente deve girare (muoversi) facilmente. RUS Деталь должна легко крутиться (двигаться). JAP 部品はしっかりと動かなければなりません。KOR 활하게 움직일 수 있어야합니다. CHI 此部件必须容易的旋转(移动)



ENG Check the mechanism for smooth and correct movement. Operate the mechanism to seat the parts in their positions. UKR Перевірте механізм на плавність і точність ходу. Розробіть механізм. DEU Prüfen Sie den Mechanismus bezüglich der Laufruhe und der Genauigkeit des Ganges. Arbeiten Sie den Mechanismus aus. FRA Vérifiez si le mécanisme fonctionne en douceur et avec précision. Faites fonctionner le mécanisme jusqu'à son fonctionnement normal. POL Sprawdź płynność i dokładność ruchu mechanizmu. Dopracuj mechanizm. SPA Verifique la suavidad y precisión del mecanismo. Desarrolle el mecanismo. ITA Controllare la scorrevolezza e la precisione del movimento. Far funzionare il meccanismo. RUS Проверьте механизм на плавность и точность хода. Разработайте механизм. JAP 駆動部分が滑らかに動くかを確認しながら作業をすすめます。KOR 구동 부분의 원활한 작동과 정확한 움직임을 확인하세요. CHI 检查机构的运行平稳度和精密度。调试机构



ENG Do not fully press the outer parts (structural frame) together until checking for fit and alignment of internal parts. UKR Деякий час не притискайте сильно деталі (рамки конструкції). DEU Drücken Sie die Teile (die Rahmen der Konstruktion) momentan nicht stark. FRA Ne pas forcer sur les pièces (cadre de la construction). POL Twymczasowo nie dociskaj elementów (ramy konstrukcji). SPA No presione temporalmente con fuerza la piezas (marco de la estructura). ITA Non stringere provvisoriamente i componenti con forza (base della costruzione). RUS Временно сильно не прижимайте детали (рамки конструкции). JAP 内部部品がしっかりと組み立てられる前に外部部品は強く押しながら固定してはいけません。KOR 아직은 외부의 틀을 완전히 눌러서 고정하면 안됩니다. 다른 부품을 먼저 끼우세요. CHI 在检查内部零件的配合和对准之前, 请暂时不要将外部零件(结构框架)完全压在一起。



ENG Place symmetrically. UKR Розташуйте симетрично. DEU Ordnen Sie sie symmetrisch. FRA Placez les de façon symétrique. POL Rozmieść symetrycznie. SPA Disponga simétricamente. ITA Sistemare gli elementi simmetricamente. RUS Расположите симметрично. JAP シンメトリ(左右対称) KOR 중간으로 정렬해 주세요. CHI 调试对称度



ENG Sand to remove burrs. UKR Видаліть задирки. DEU Grate entfernen. FRA Éliminez les bavures. POL Usuń zadziory. SPA Quite las rebabas. ITA Togliere le bave. RUS Удалите заусенцы. JAP バリ取りのサンドペーパー KOR 거친 부분을 닦아주세요. CHI 磨掉毛刺



ENG Break off or cut out. UKR Відламайте або відріжте. DEU Abbrechen oder Abschneiden. FRA Coupez ou cassez. POL Odlam lub odetnij. SPA Rompa o corte. ITA Staccare o tagliare. RUS Отломайте или отрежьте. JAP 切ってください。KOR 잘라내 주세요. CHI 切断



UGEARS
 100% Models



ENG Spare parts. UKR Запасні деталі. DEU Ersatzteile. FRA Pièces de rechange. POL Części zamienne. SPA Piezas de repuesto. ITA Pezzi di ricambio. RUS Запасные детали. JAP 予備部品 KOR 여유 부품입니다. CHI 备用件

ENG Axle. UKR Біль. DEU Achse. FRA Axe. POL Oś. SPA Eje. ITA Asse. RUS Ось. JAP アクスル. KOR 축. CHI 軸承.

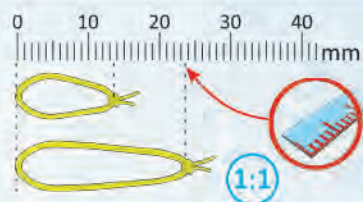
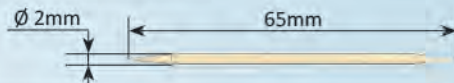

ENG Check size. UKR Перевірте розмір. DEU Prüfen Sie die Größe. FRA Vérifiez la dimension. POL Sprawdź rozmiar. SPA Compruebe el tamaño. ITA Controllare le dimensioni. RUS Проверьте размер. JAP サイズをチェックしてください。KOR 크기를 확인해 주세요. CHI 測量尺寸

ENG This is not a structural component; it is a tool for measurement and assembly. UKR Це не деталь конструкції, а допоміжний інструмент для складання або вимірювання відстаней. DEU Es ist kein Teil der Konstruktion, sondern ein Hilfselement für den Zusammenbau oder für das Messen der Abstände. FRA Cette pièce ne fait pas partie de la construction mais constitue un outil annexe pour l'assemblage ou la mesure des distances. POL To nie detal konstrukcji, a pomocnicze narzędzie dla montażu i wymiaru odległości. SPA No es una pieza de la construcción sino un instrumento auxiliar para montar o para medir distancias. ITA Non è un componente del modello, ma un'attrezzatura aggiuntiva per il montaggio o il rilievo delle quote. RUS Это не деталь конструкции, а вспомогательный инструмент для сборки или измерения расстояний. JAP この部品は完成時の部品ではなく、組み立てをサポートしたり測定する道具です。KOR 이 부품은 조립을 위한 부품이 아니고 조립을 돕거나 측정을 위한 도구입니다. CHI 这不是装配零部件, 是一种测量及安装辅助工具。

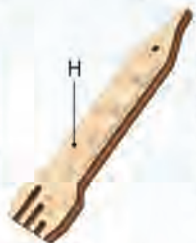

Mechanical models

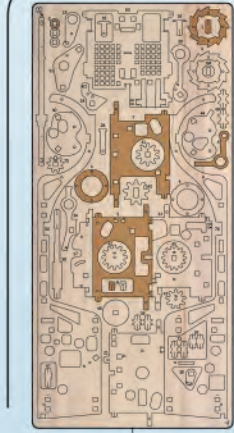

1



2

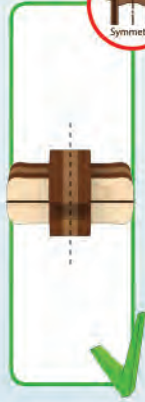

5

3

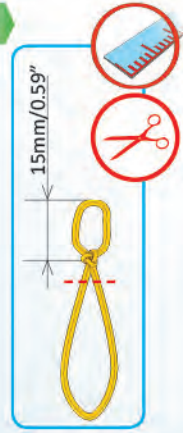

4

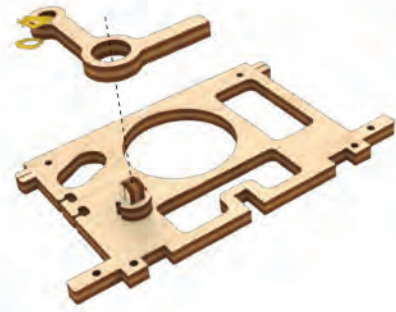

5



6

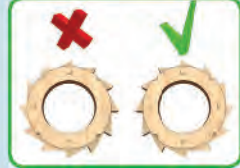
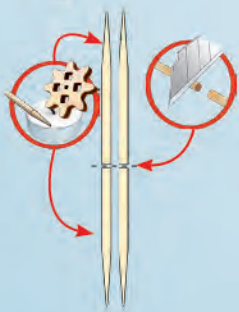

7

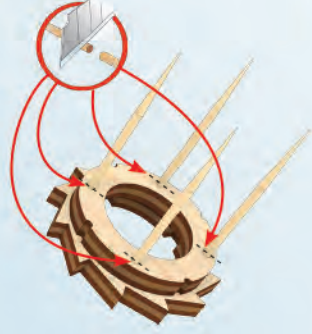

8

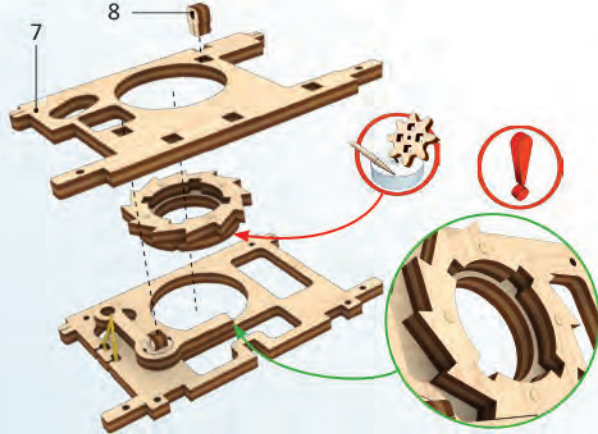

4



mm

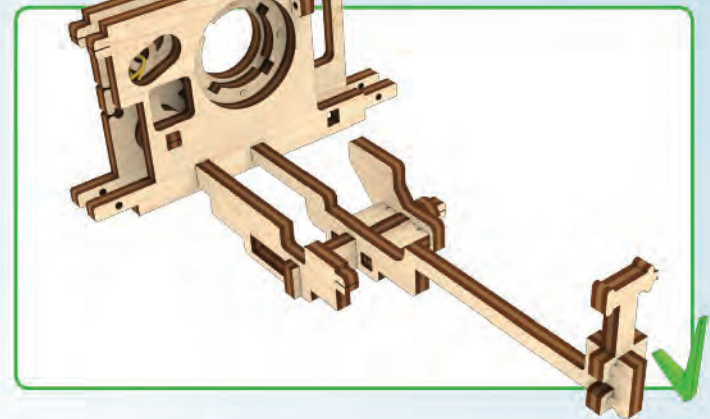
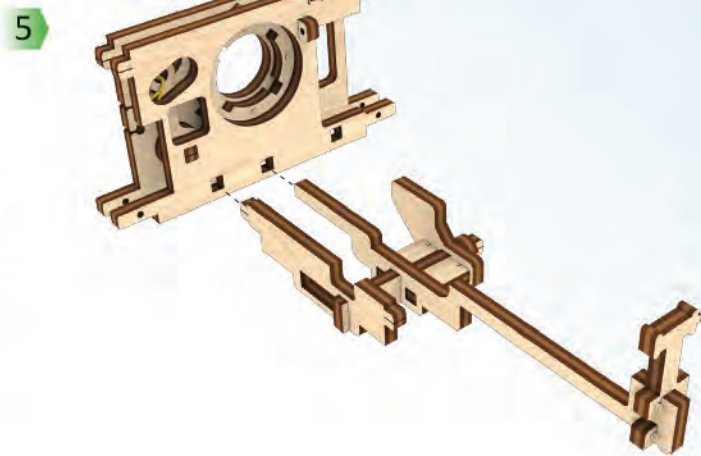
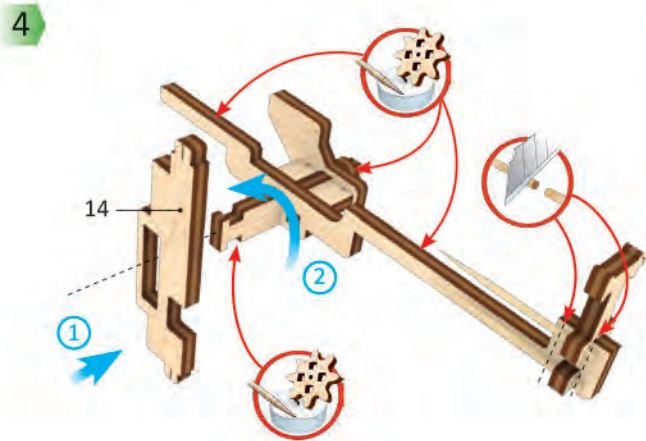
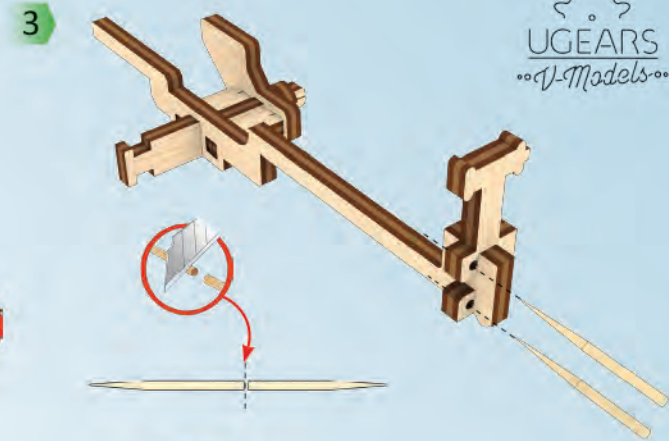
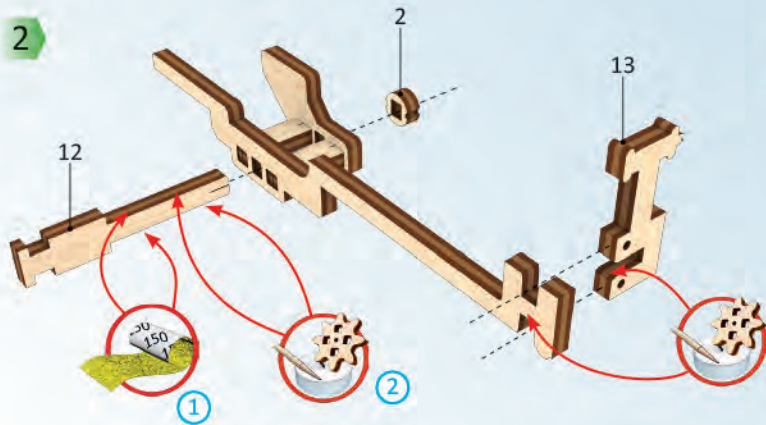
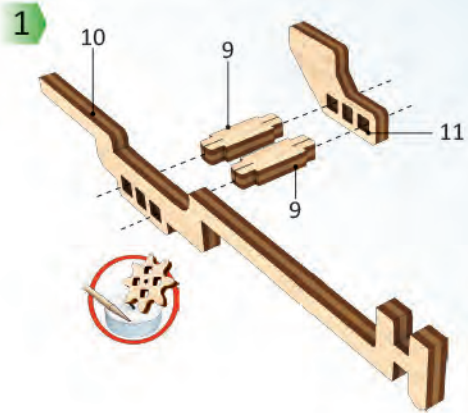
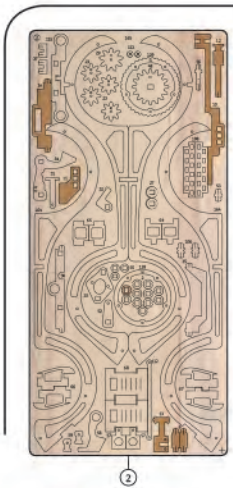

Mechanical models

1

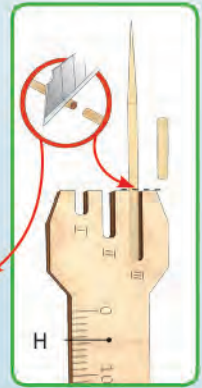

2

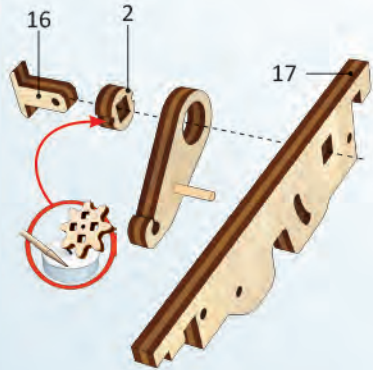

3



4

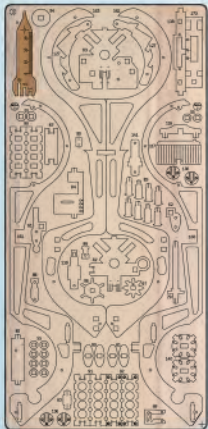
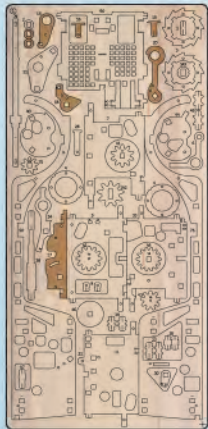
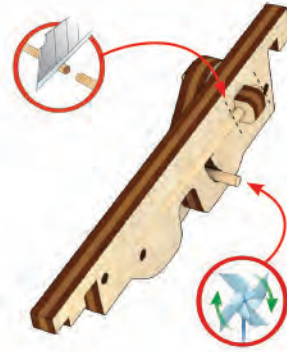

5

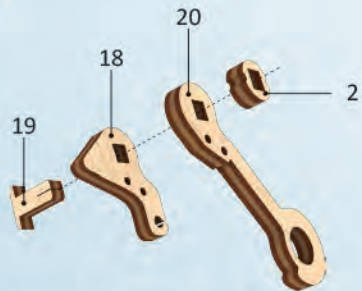

6

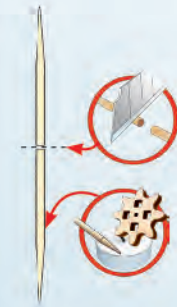

7

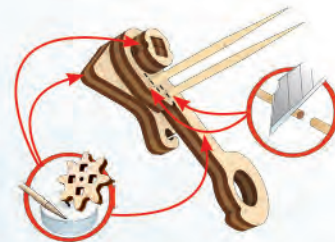

6

1

3

1

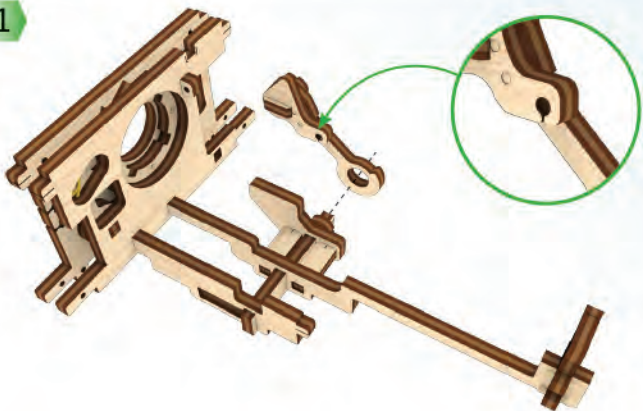

2

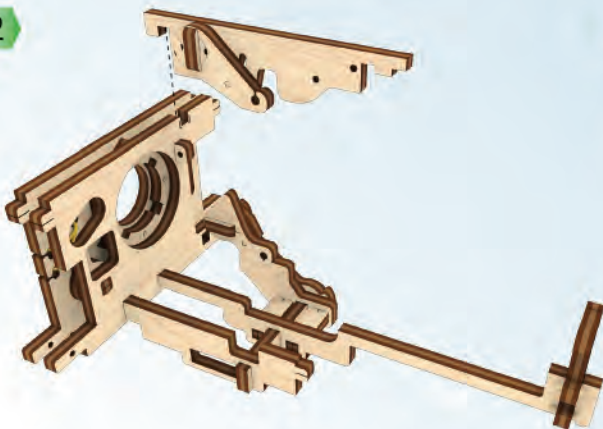

3

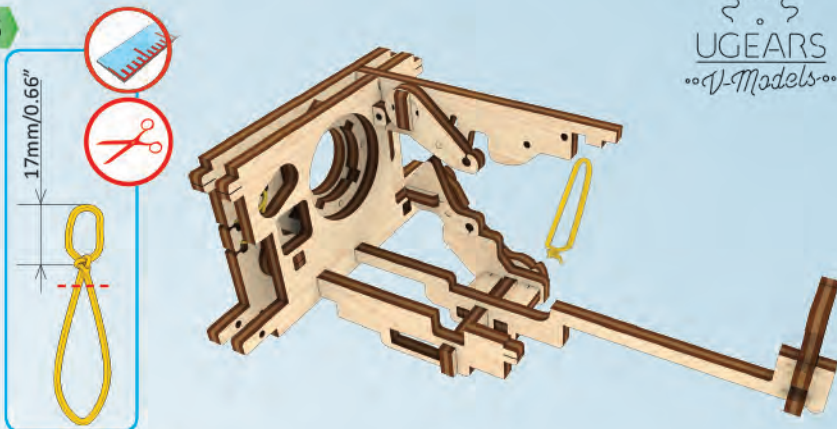

4

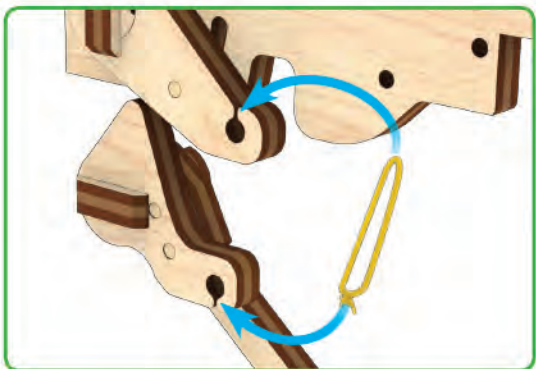

5

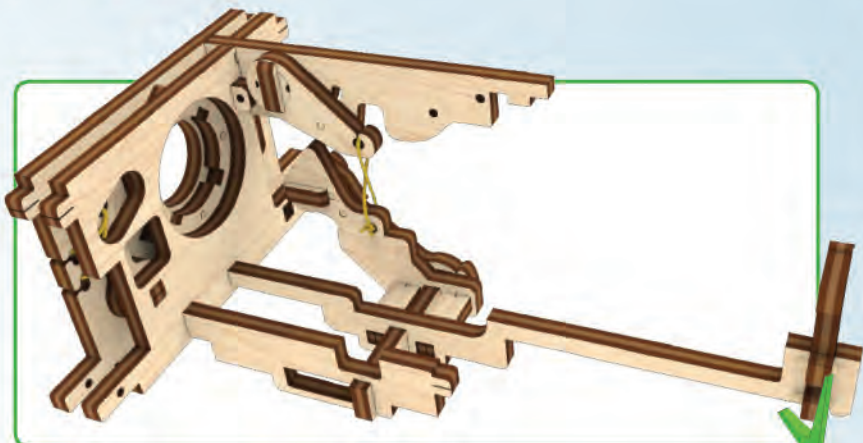
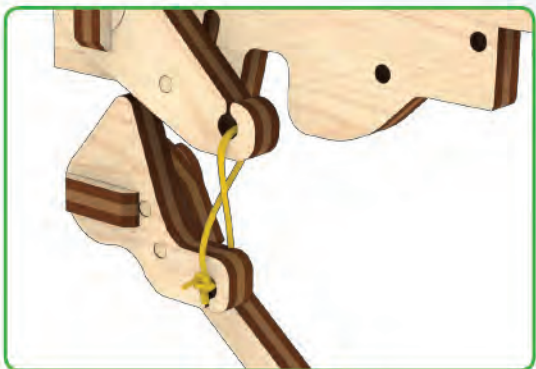

Mechanical models

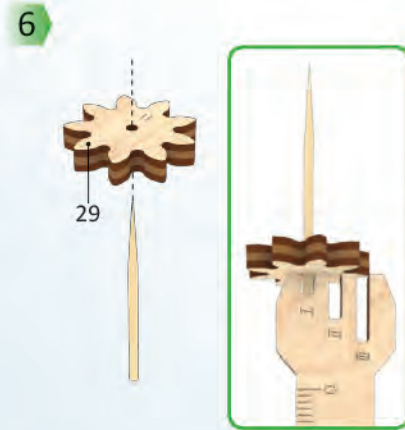
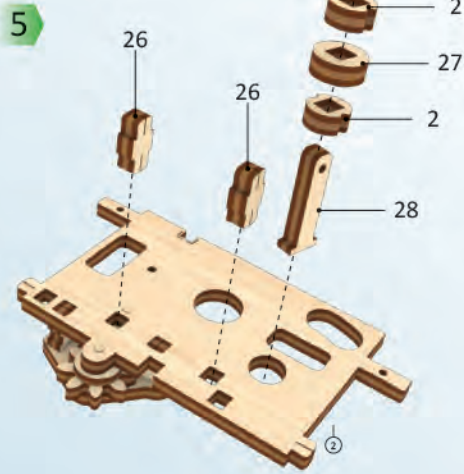
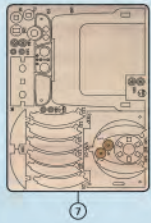
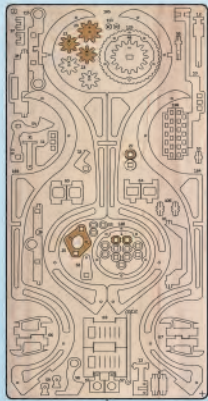
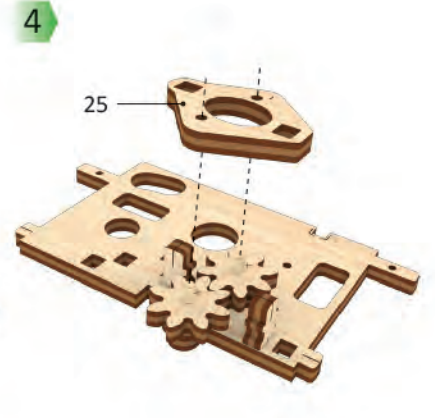
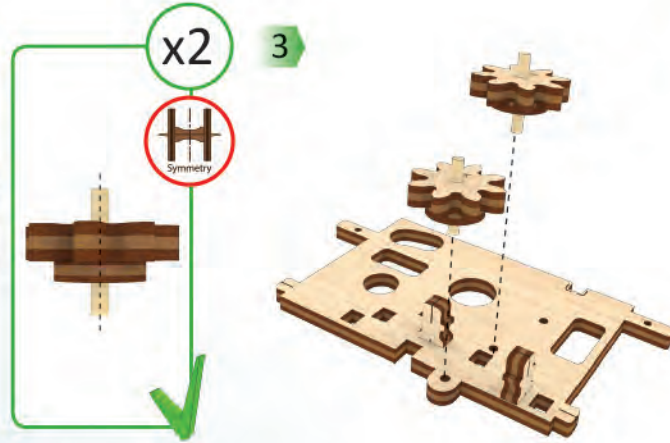
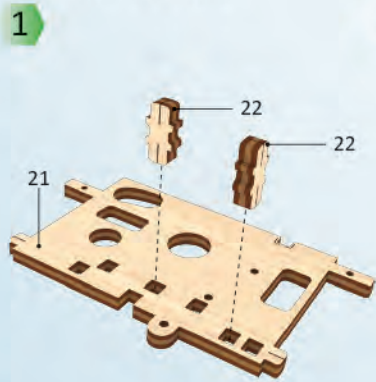
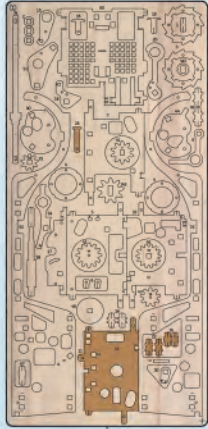

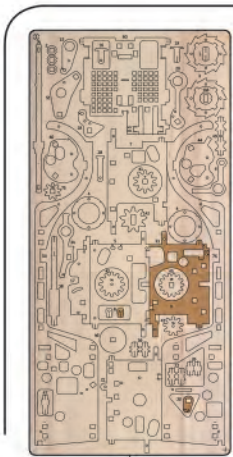

1

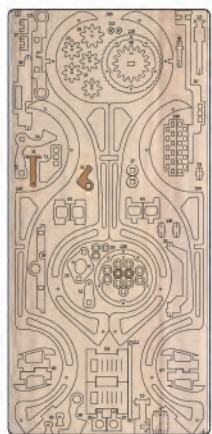
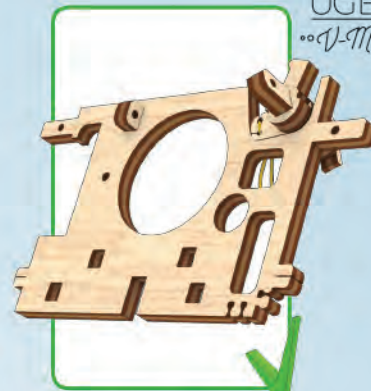
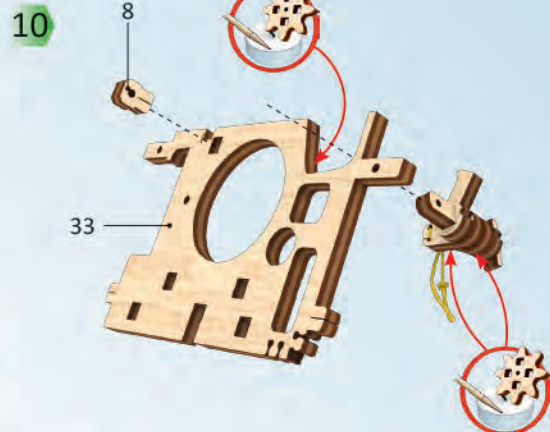
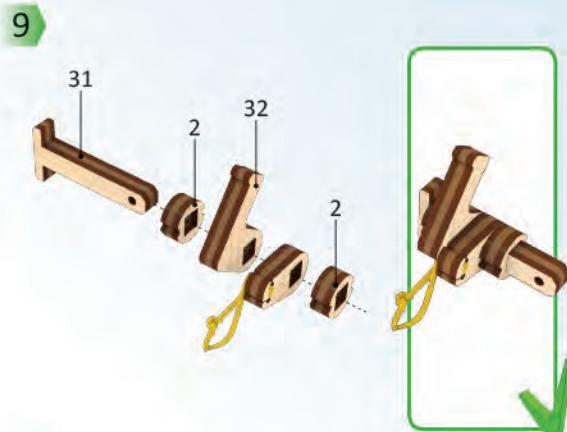
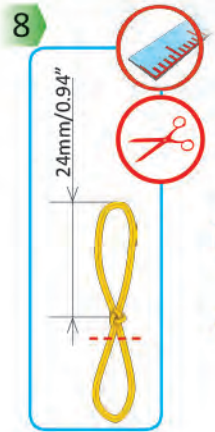

2

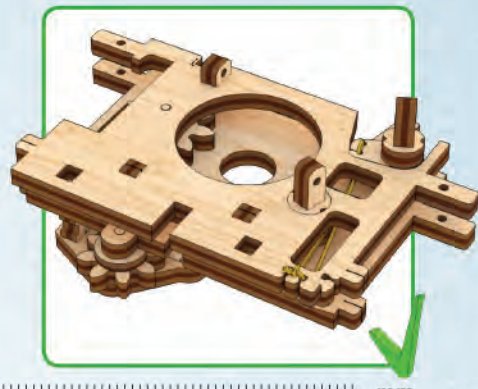
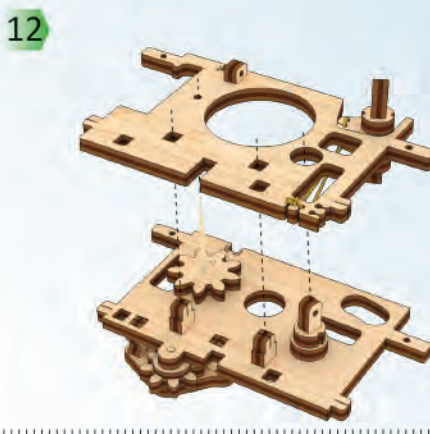
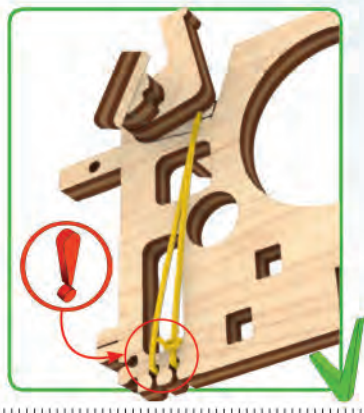
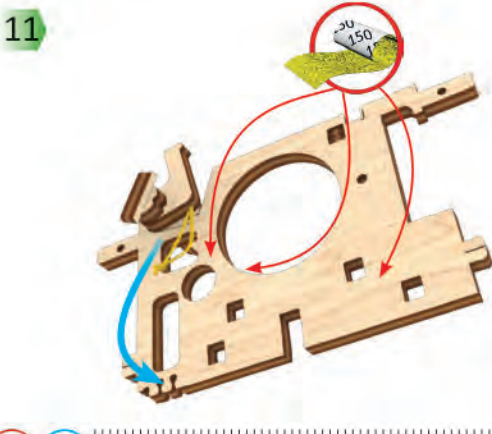

9

Mechanical models

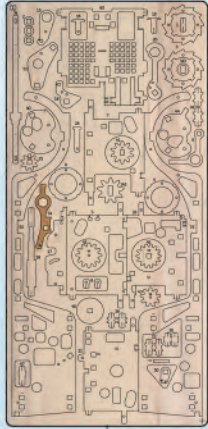

1

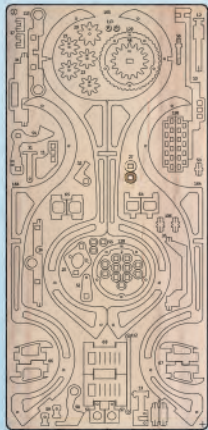
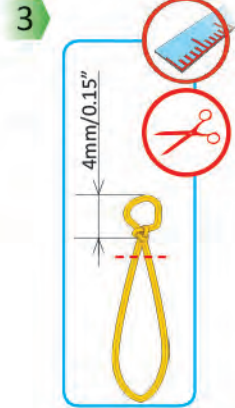
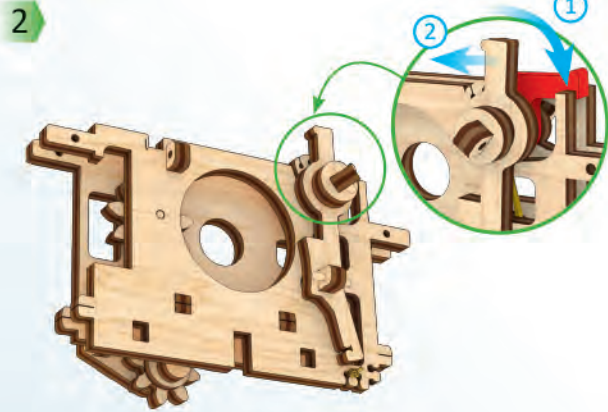
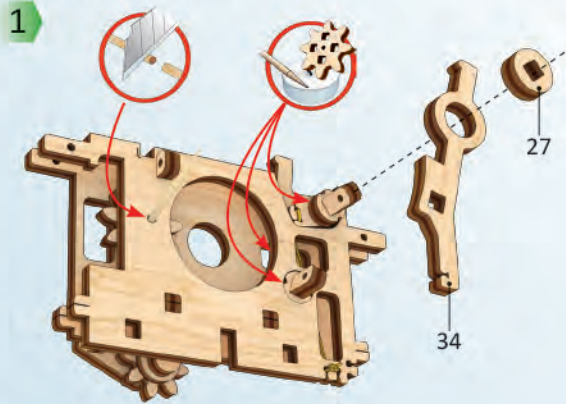

2

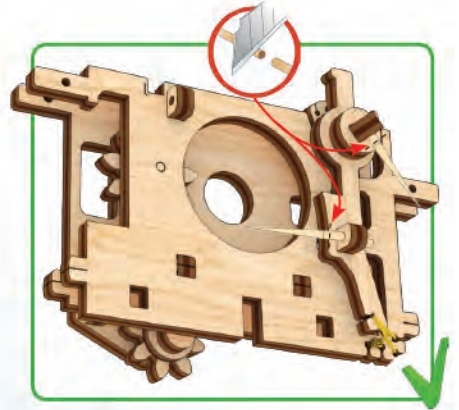
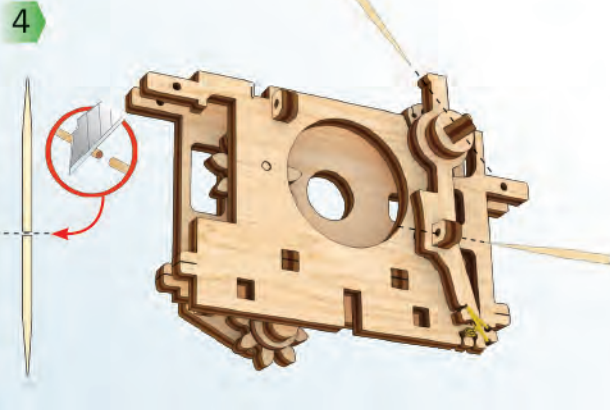

10



1:1

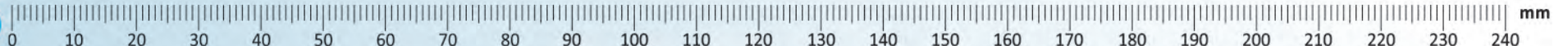

mm

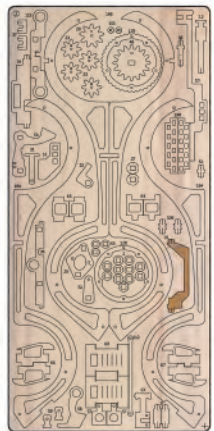

1

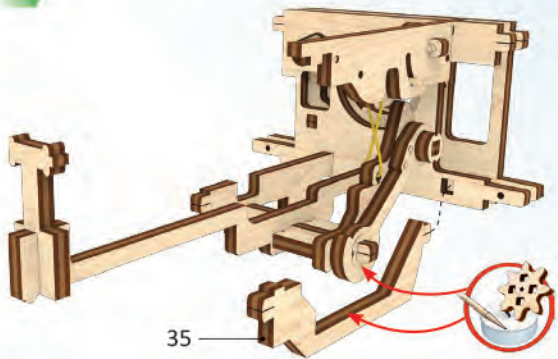

2

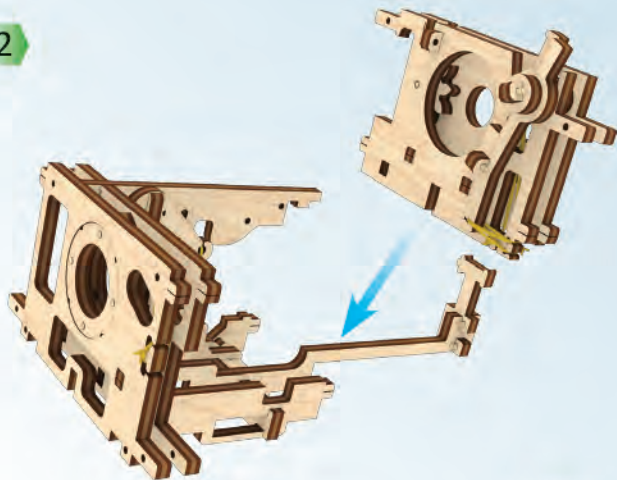

3

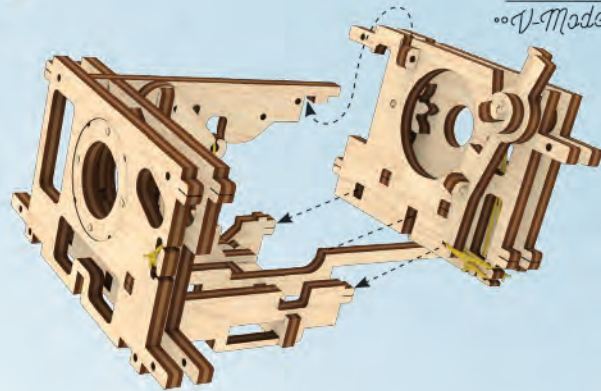

4

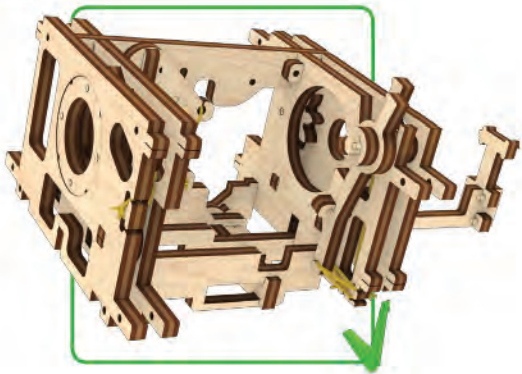

5

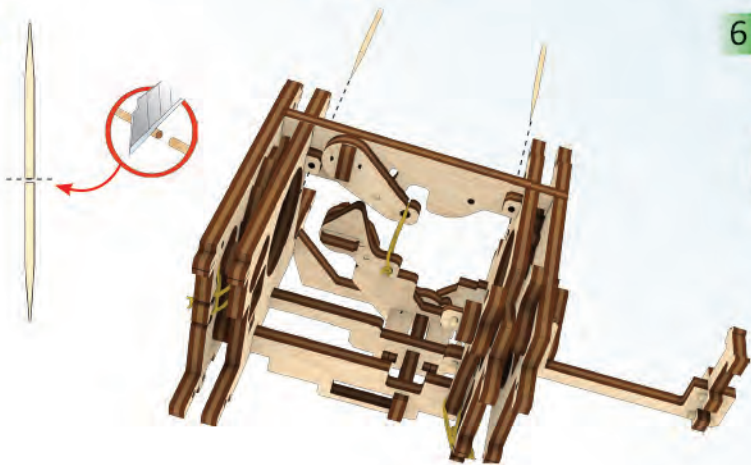

6

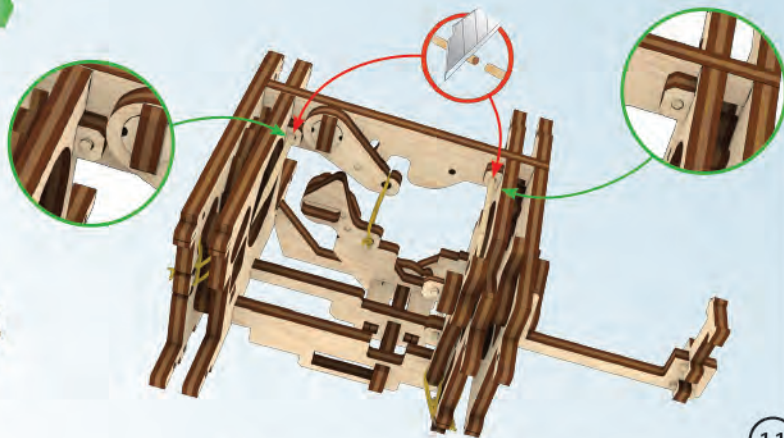

Mechanical models

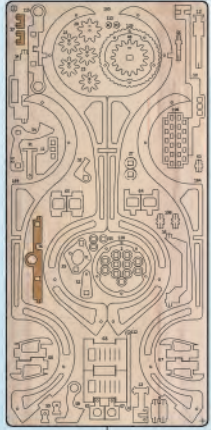

1

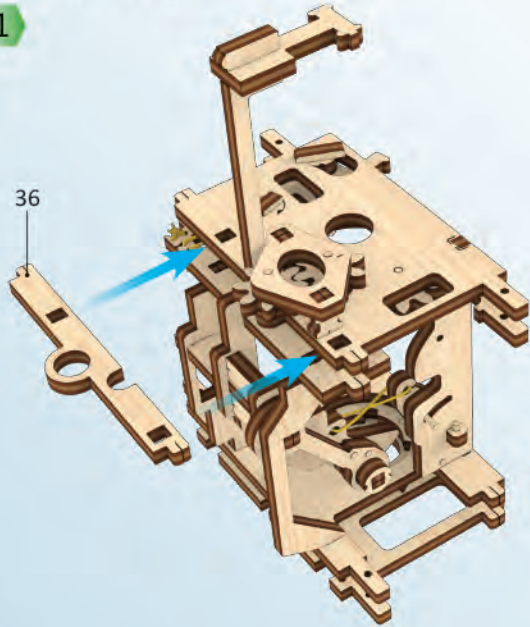

2

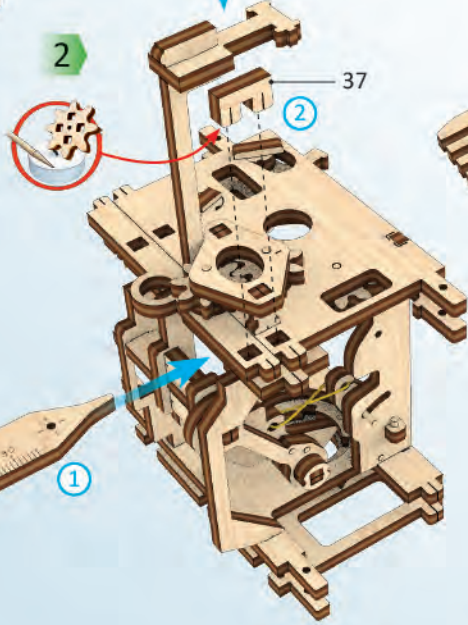

3

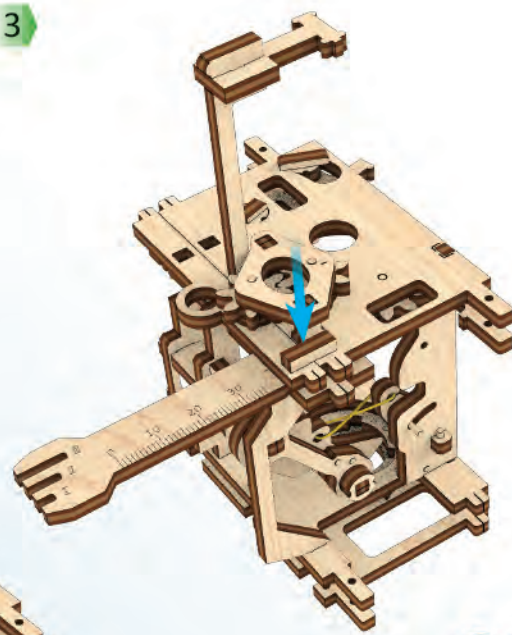

4

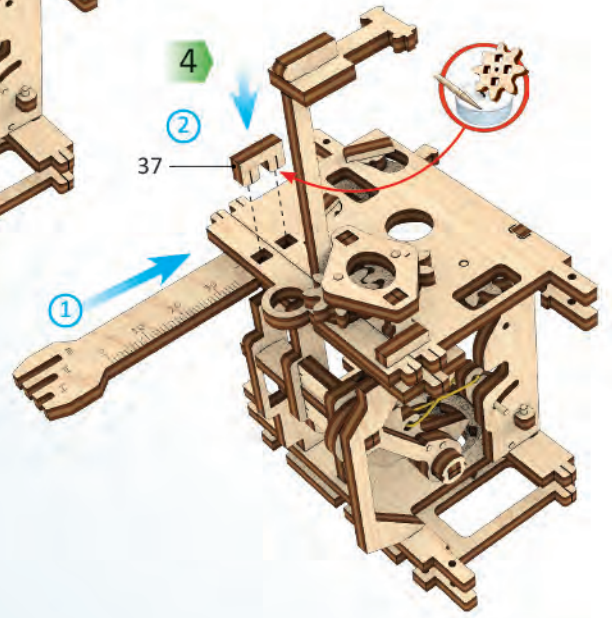

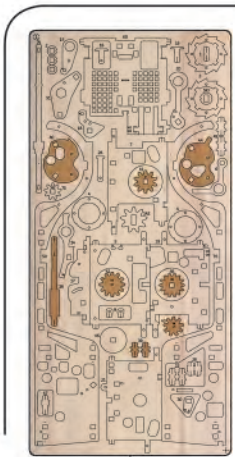

1

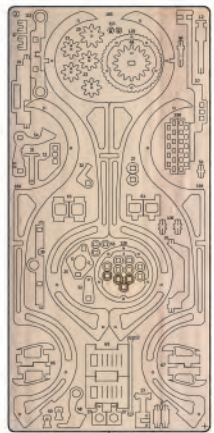
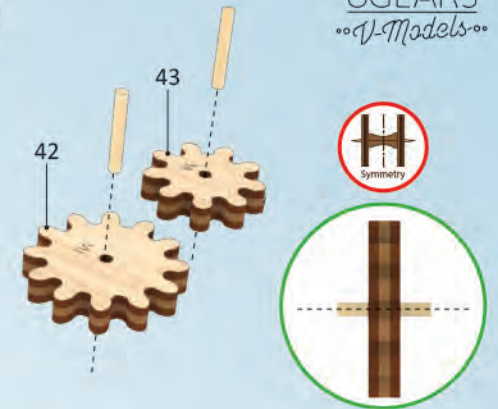
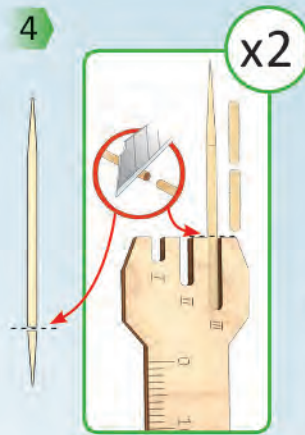
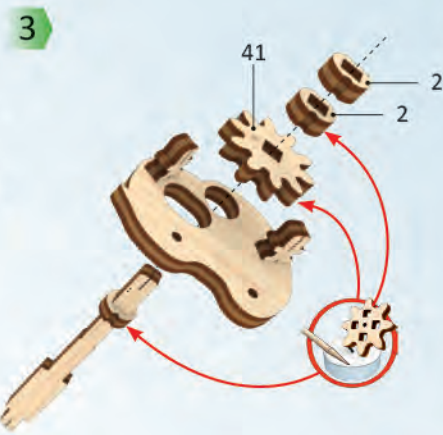
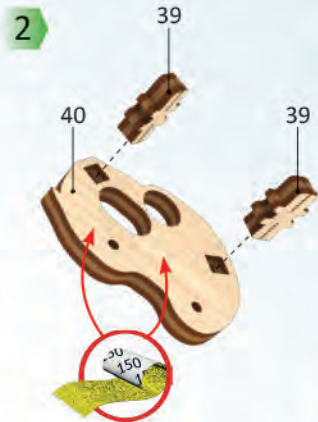
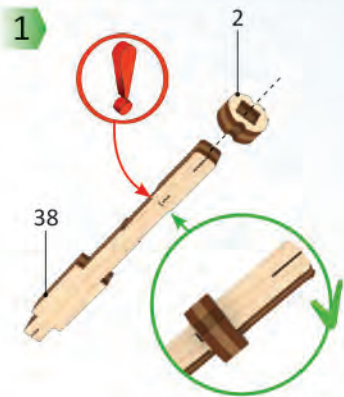

2

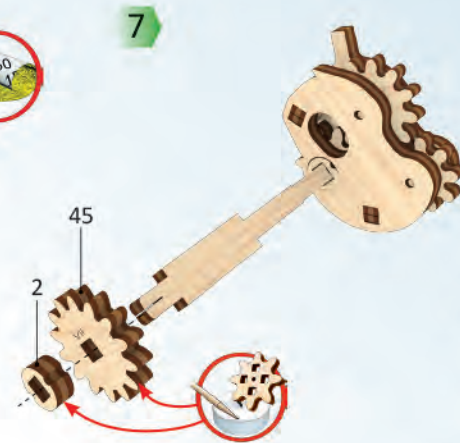
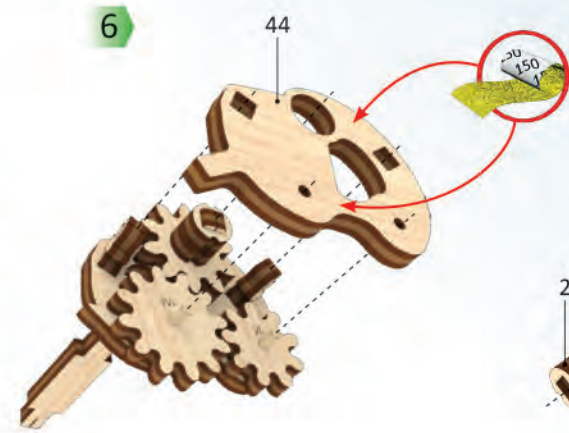
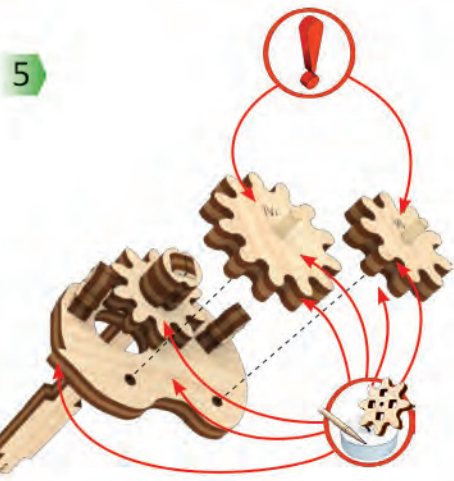

Mechanical models

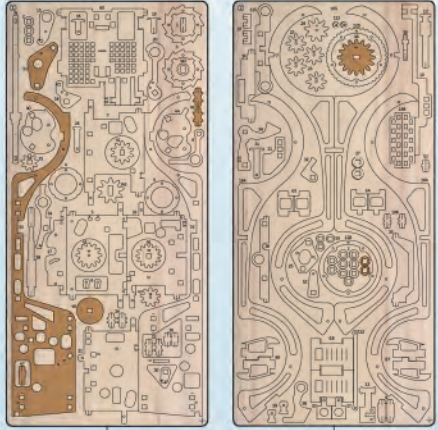

1

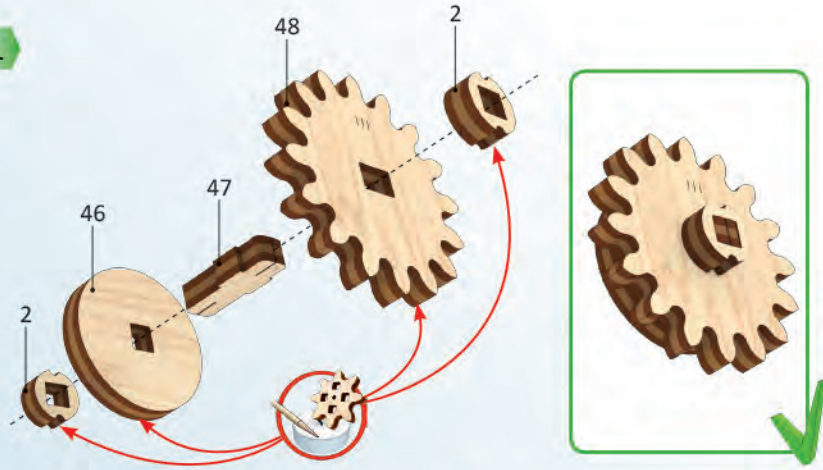

2

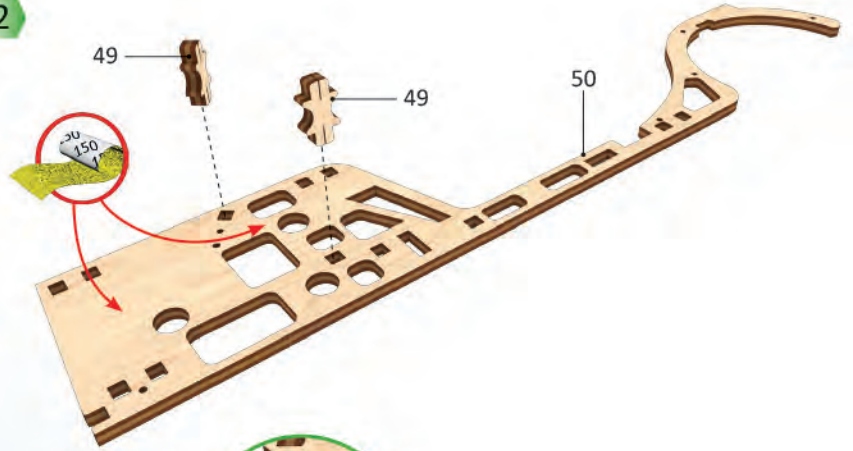

3

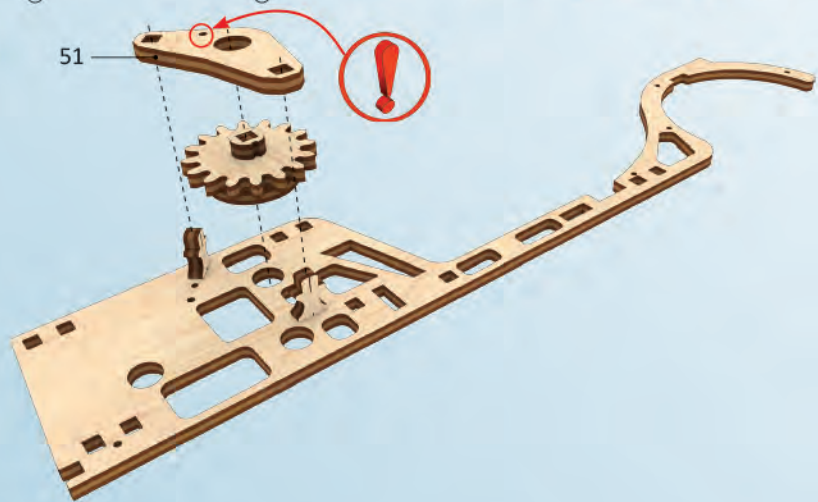

4

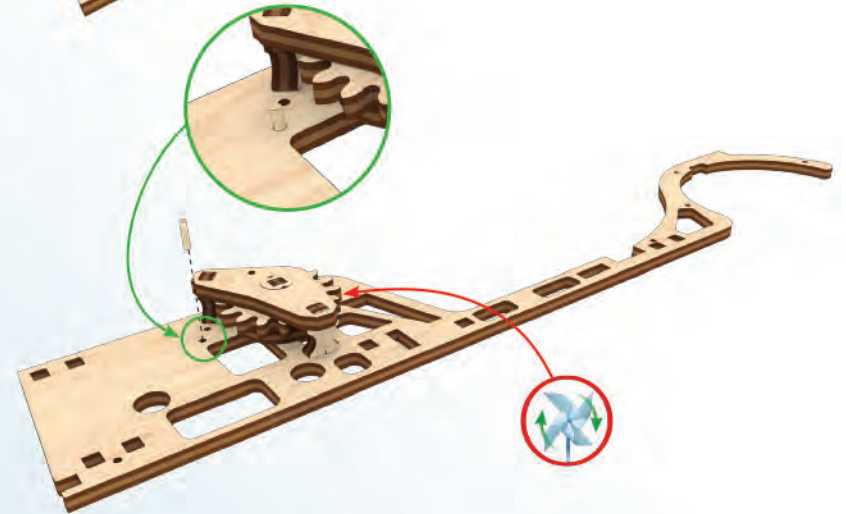
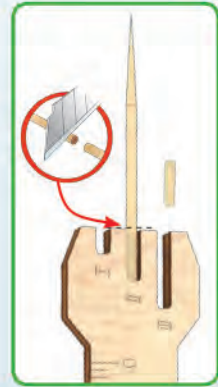

1

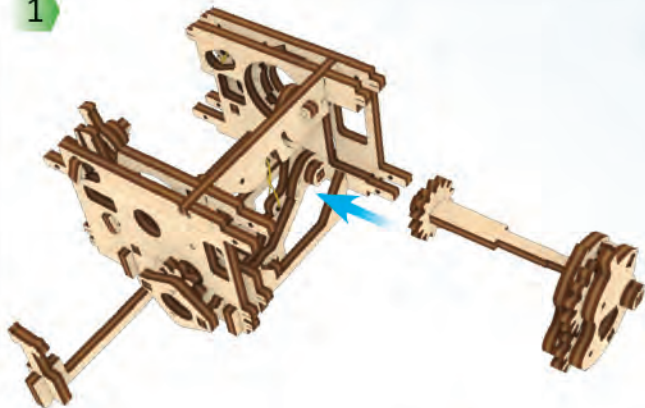

2

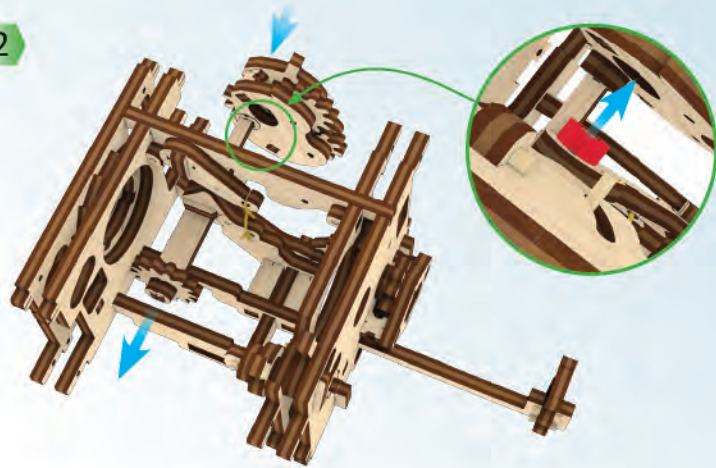

3

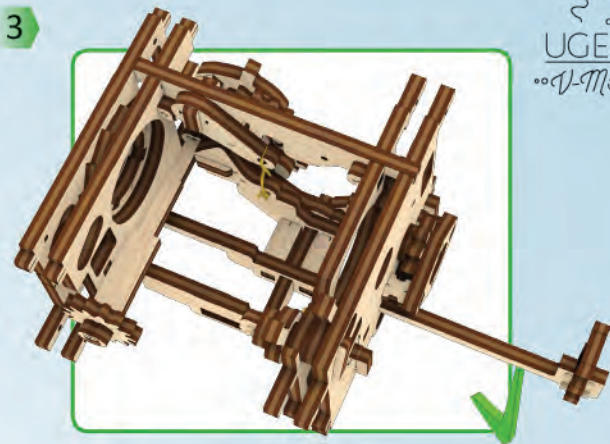

4

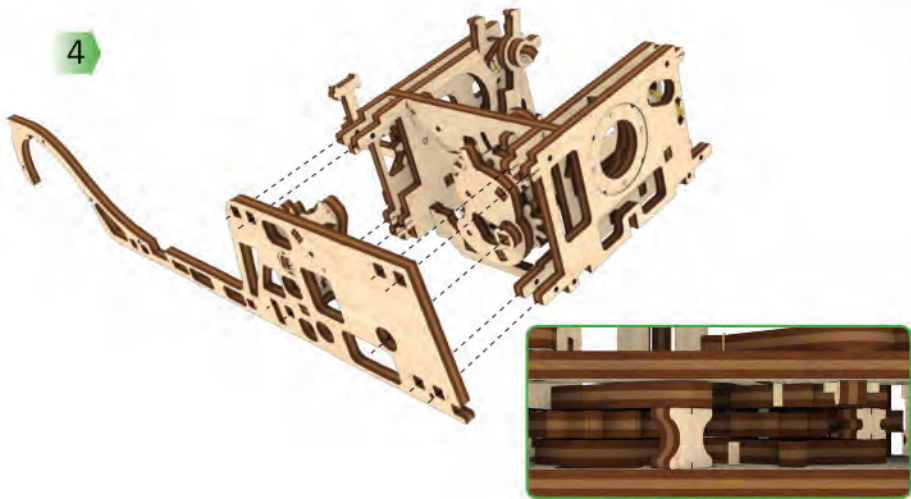

5

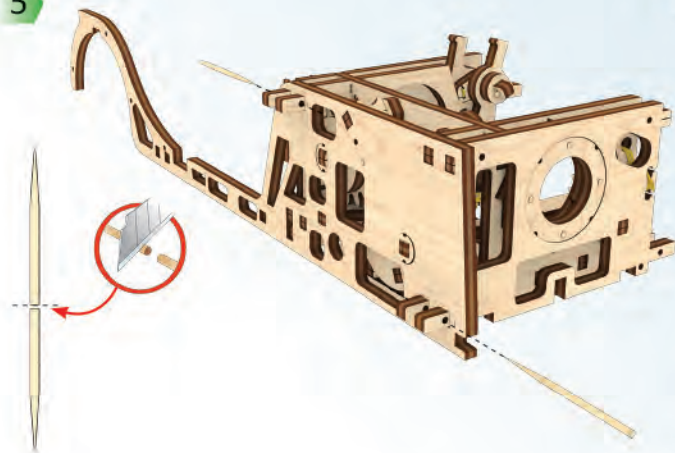

6

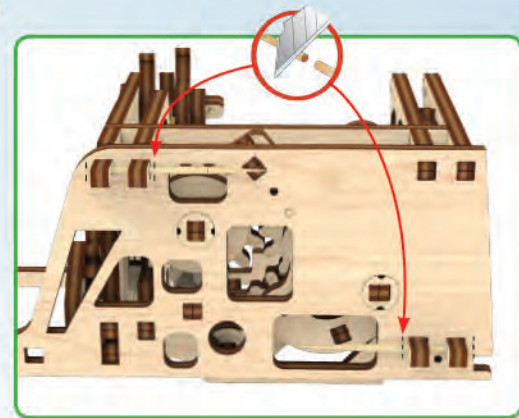

Mechanical models

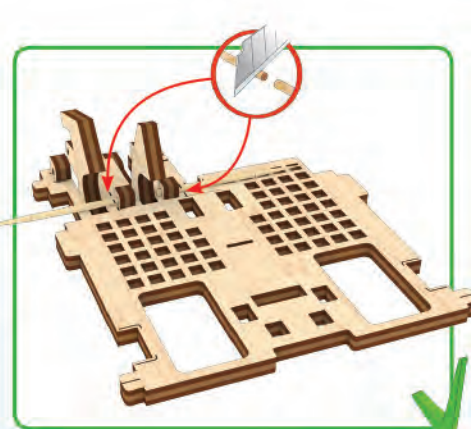
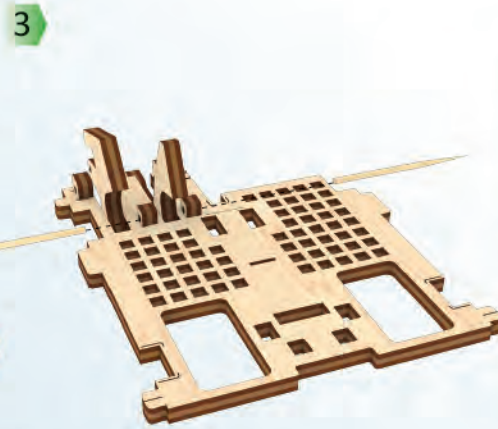
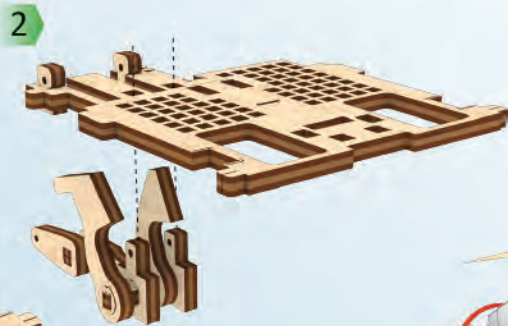
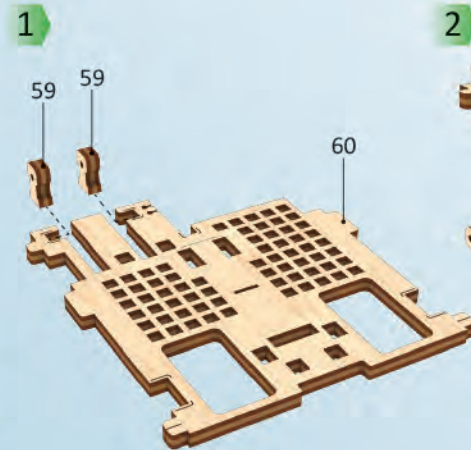
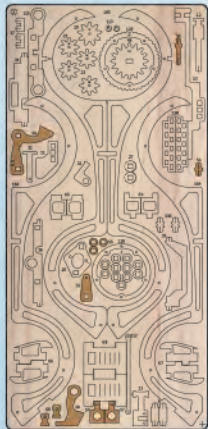
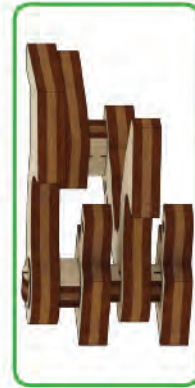
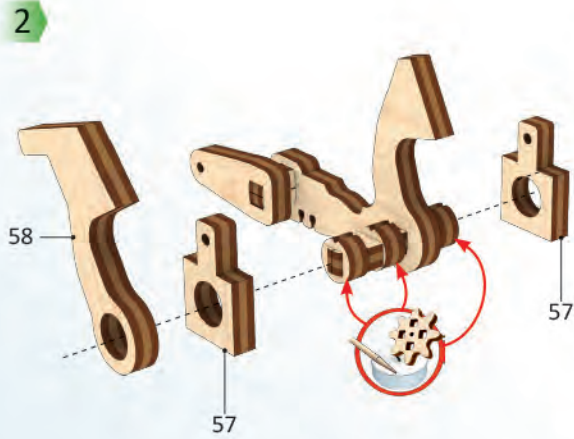
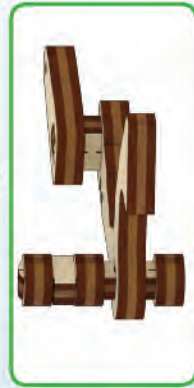
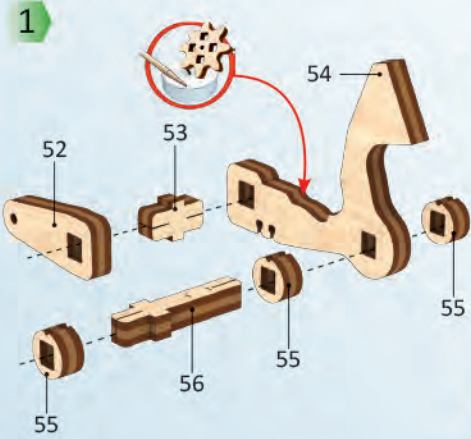
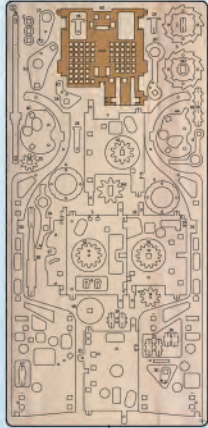

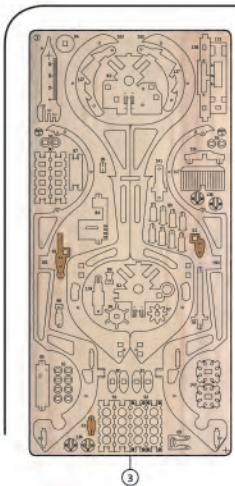

1

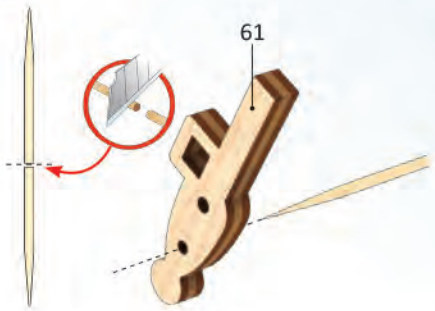

2

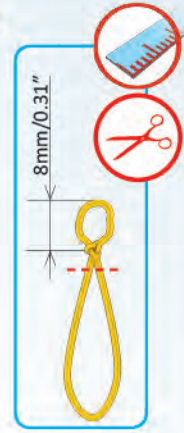

3

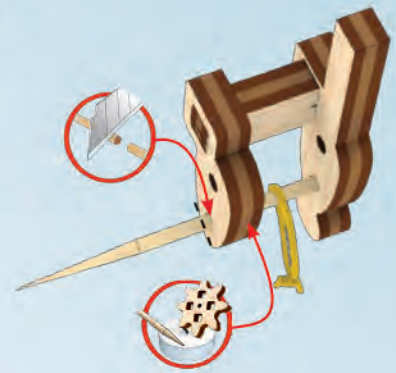
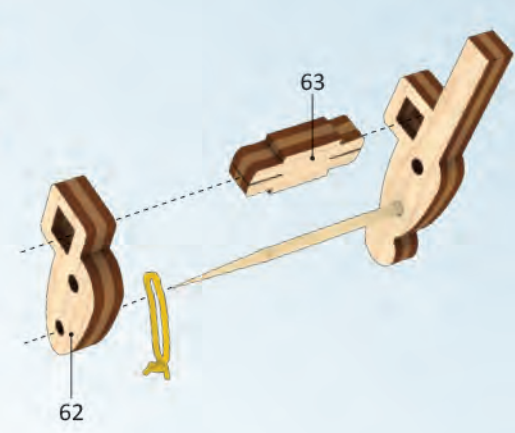

4



5

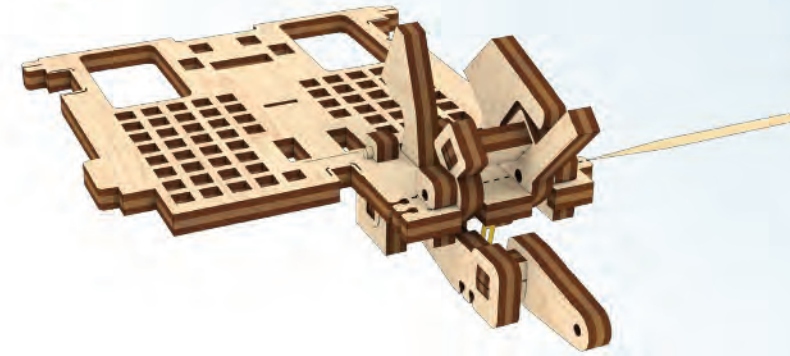

6

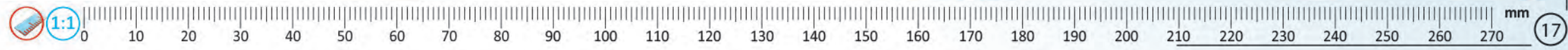
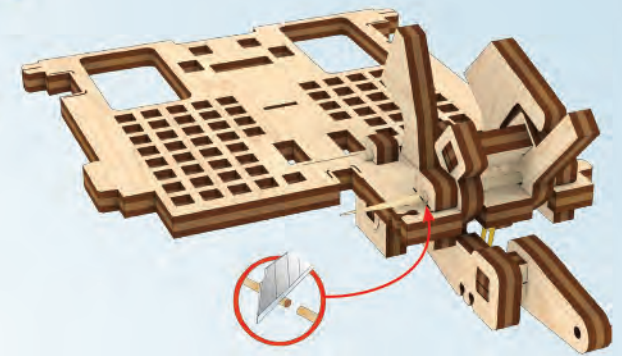

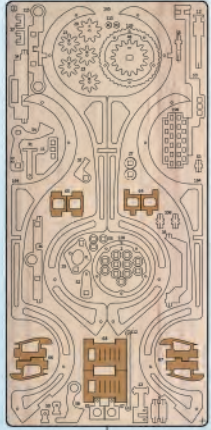

1

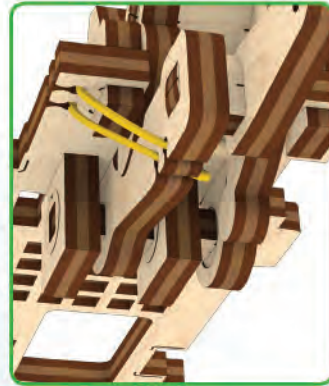
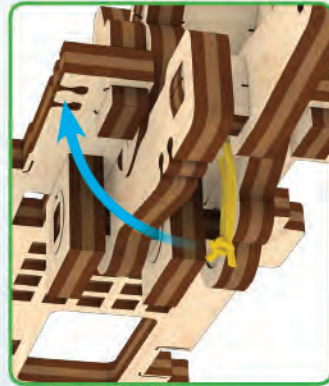
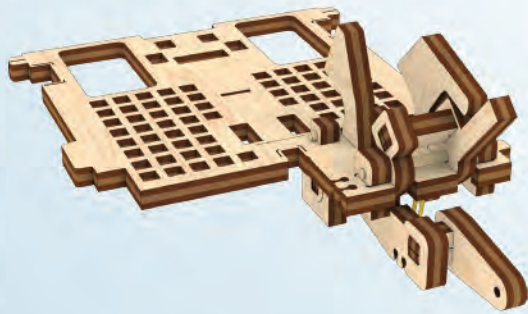

2

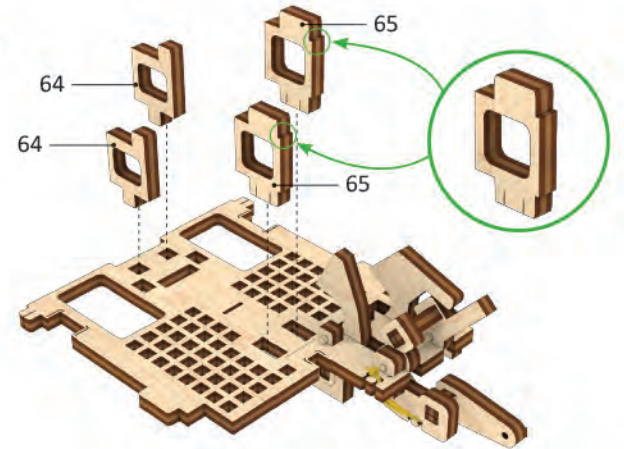

3

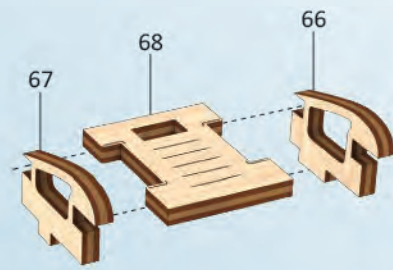
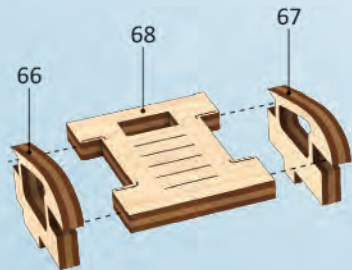

4

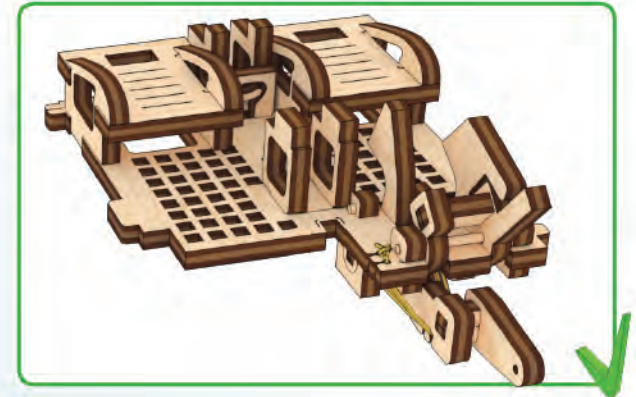
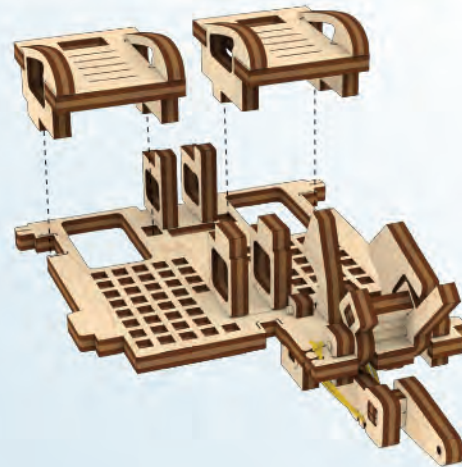

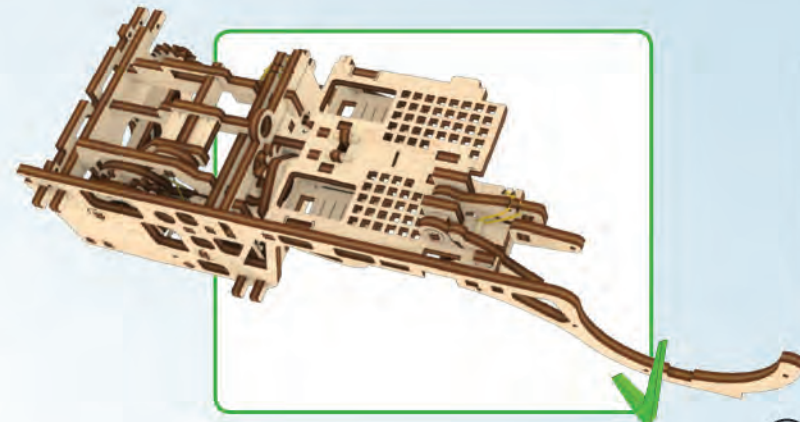
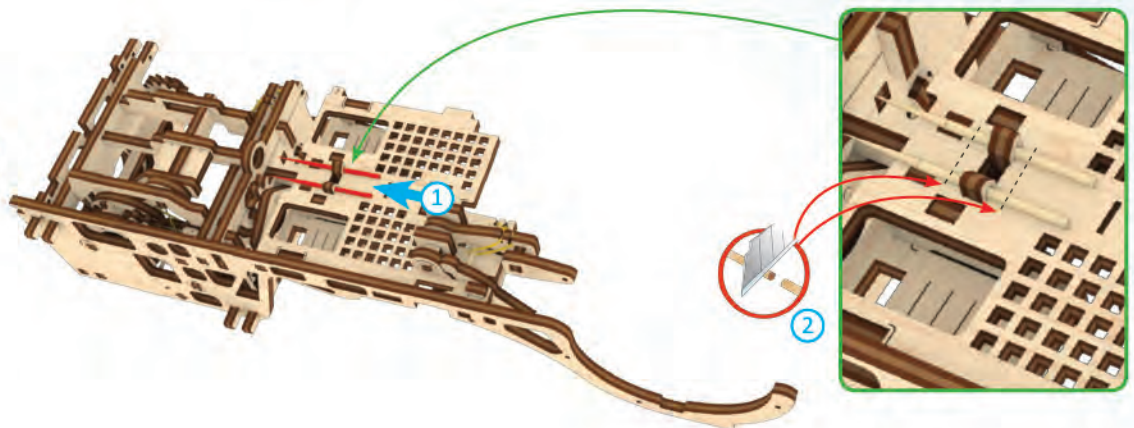
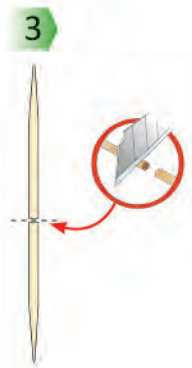
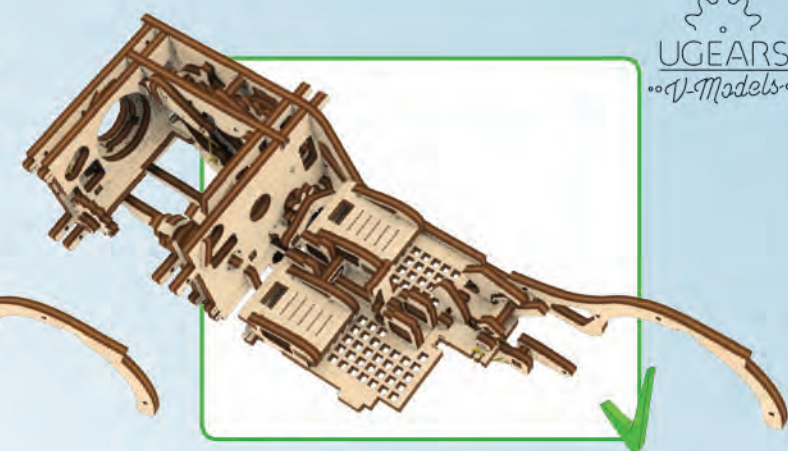
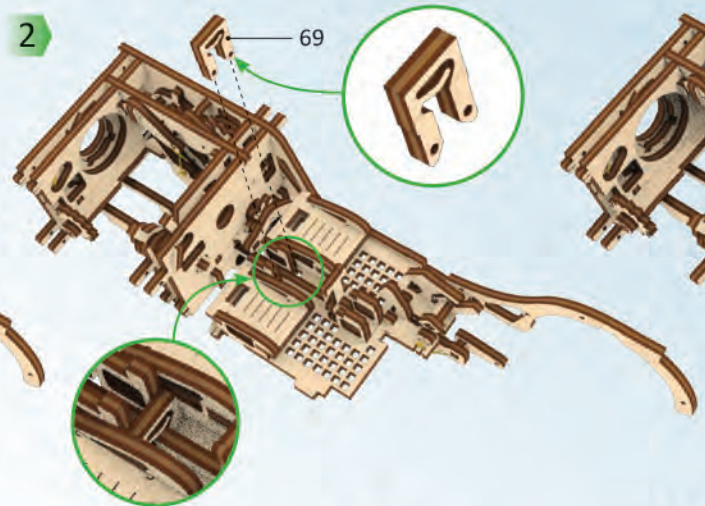
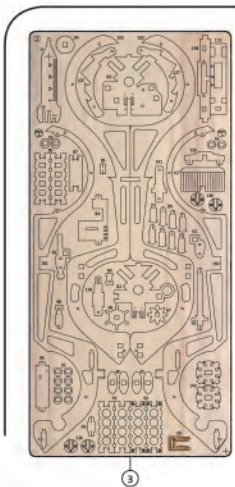

Mechanical models

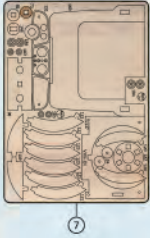
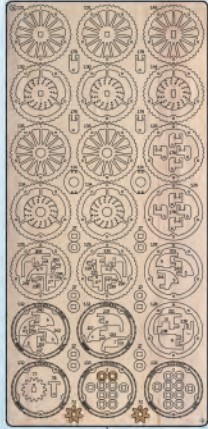

1

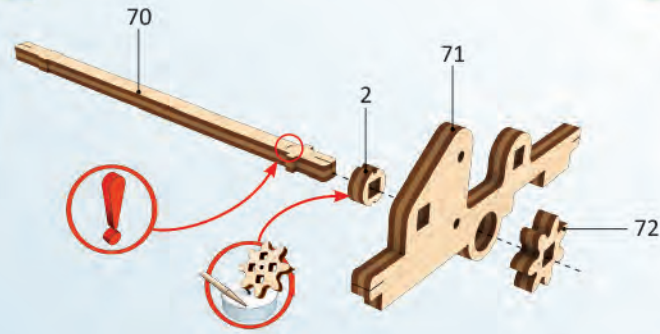

2

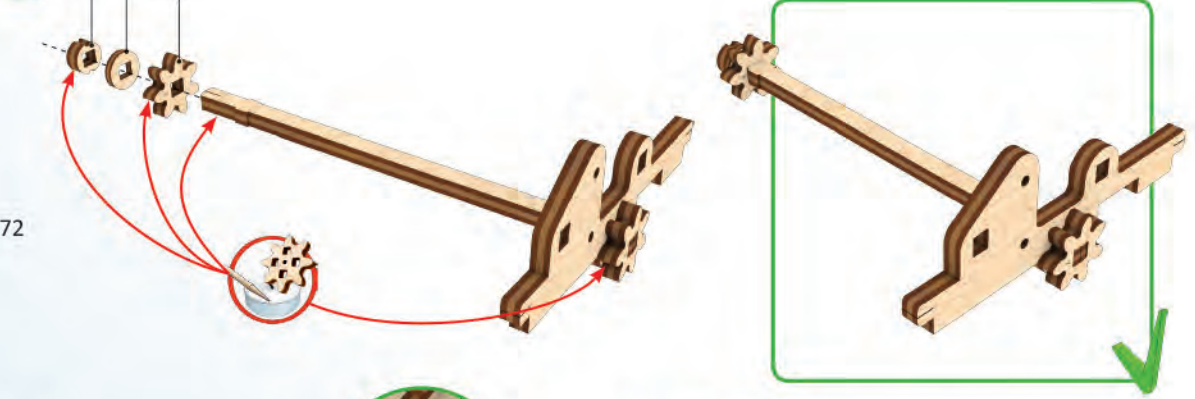

3

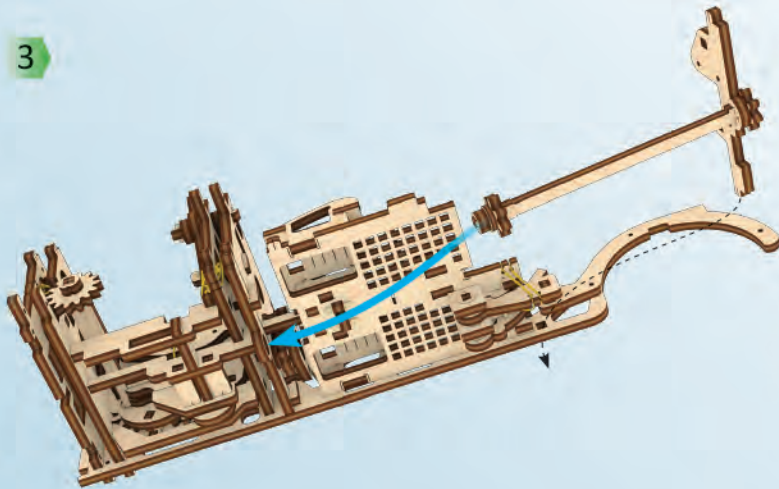

4

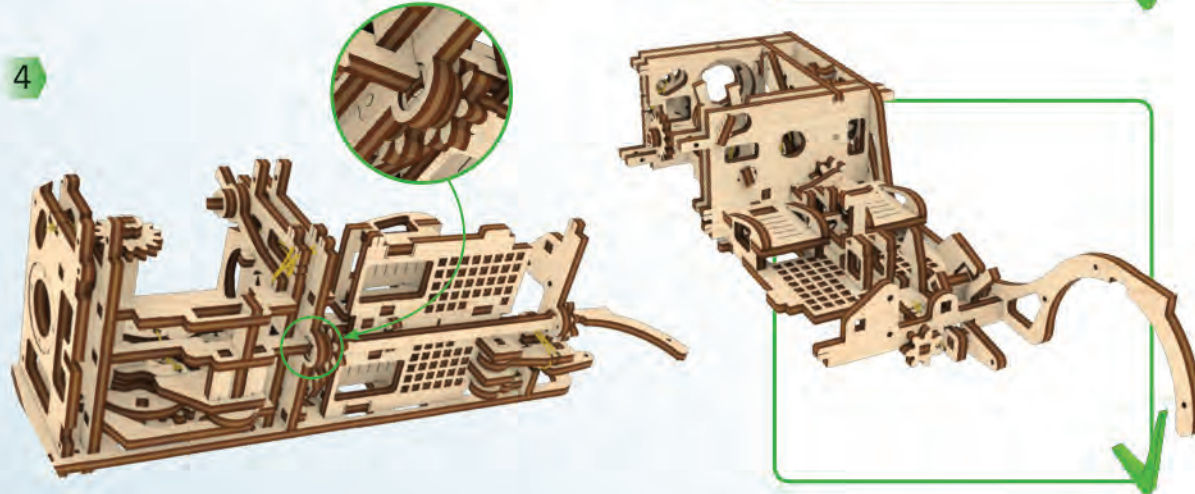

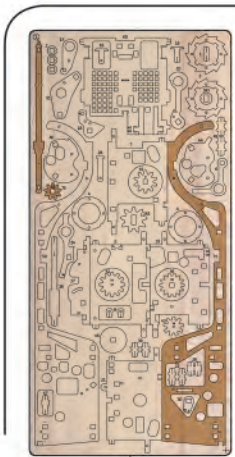

1

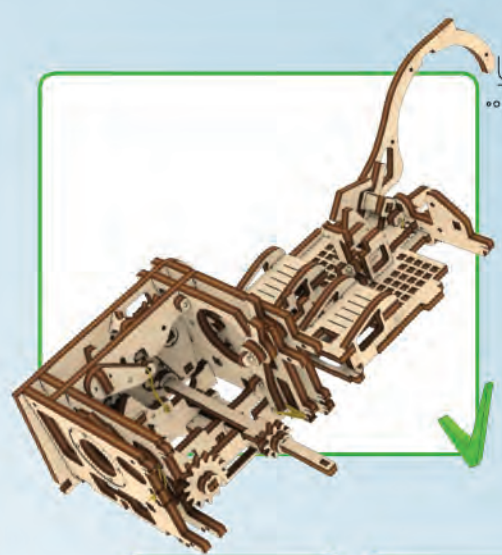
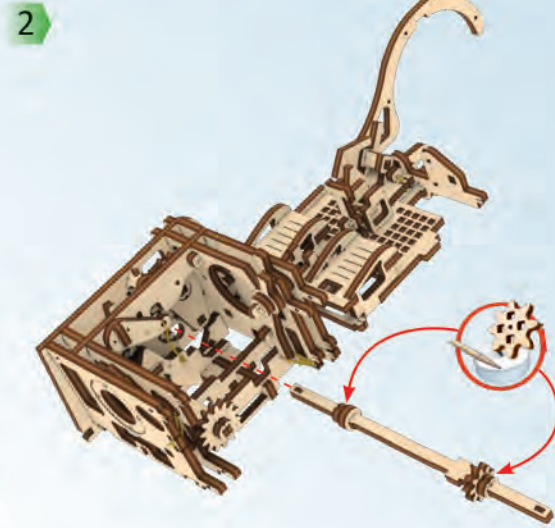
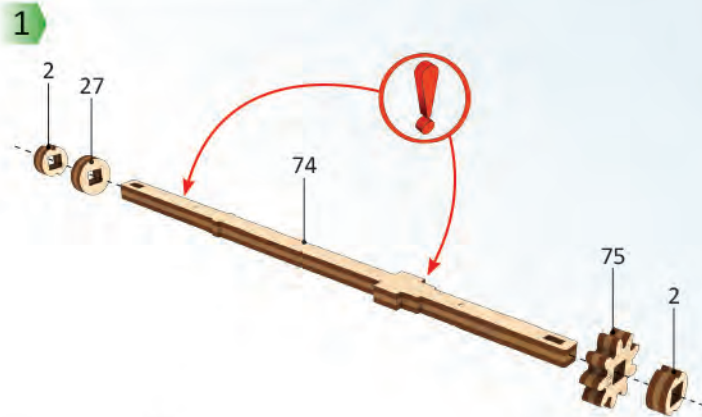

2

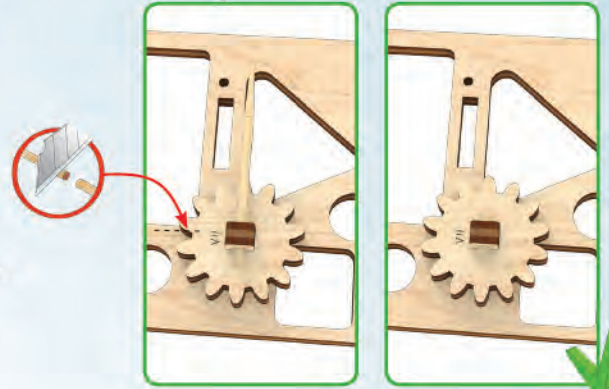
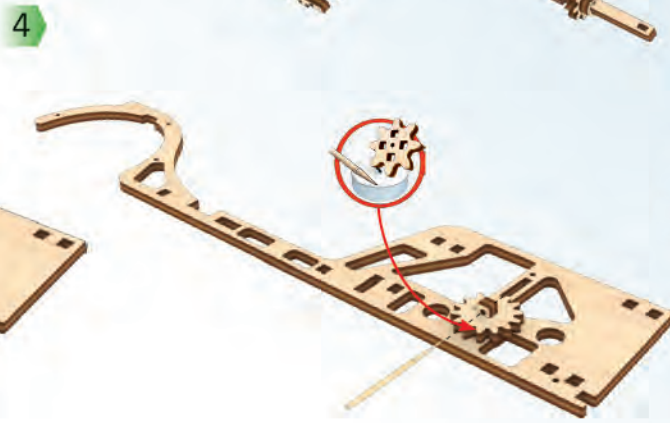
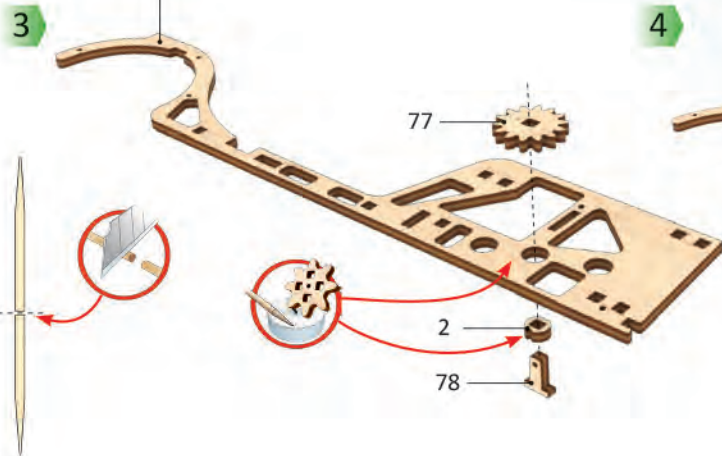

Mechanical models

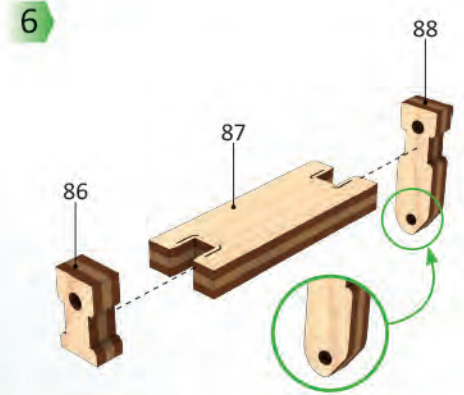
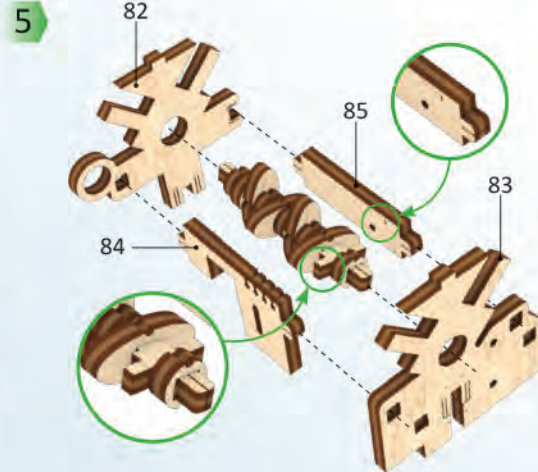
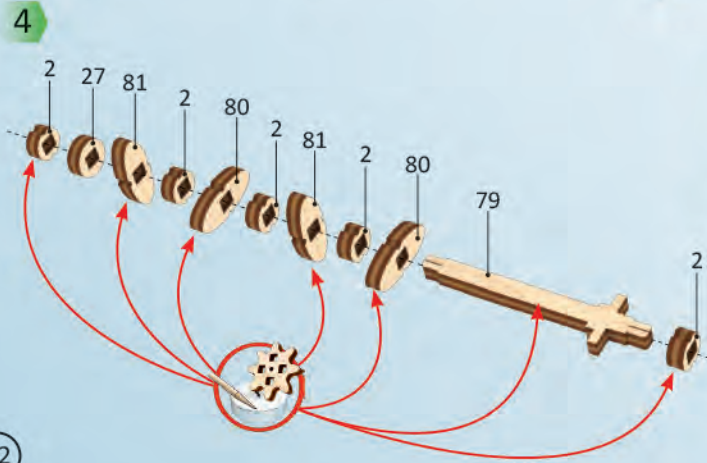
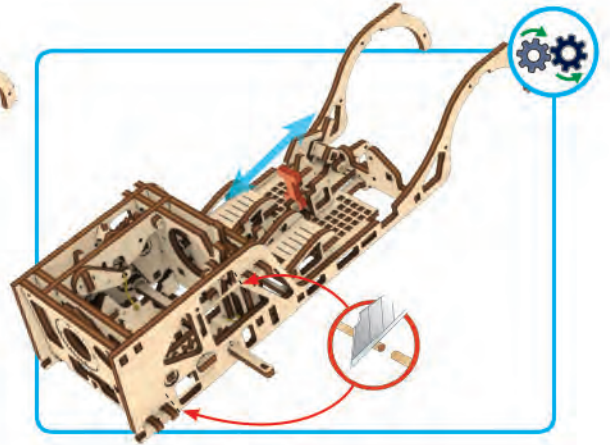
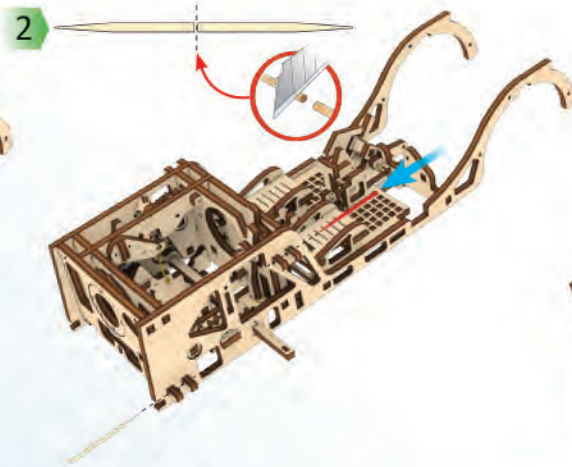
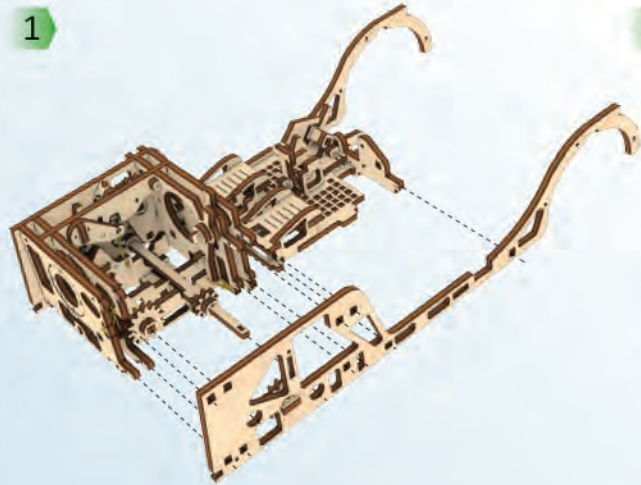
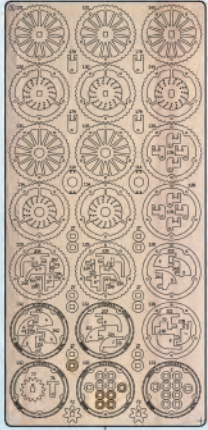
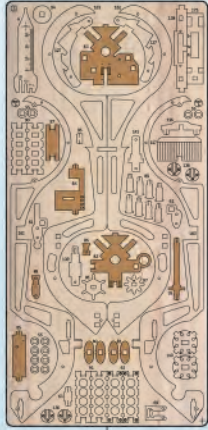

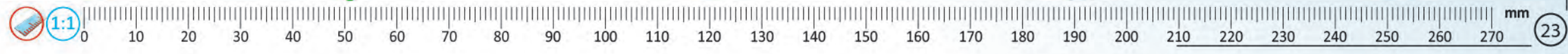
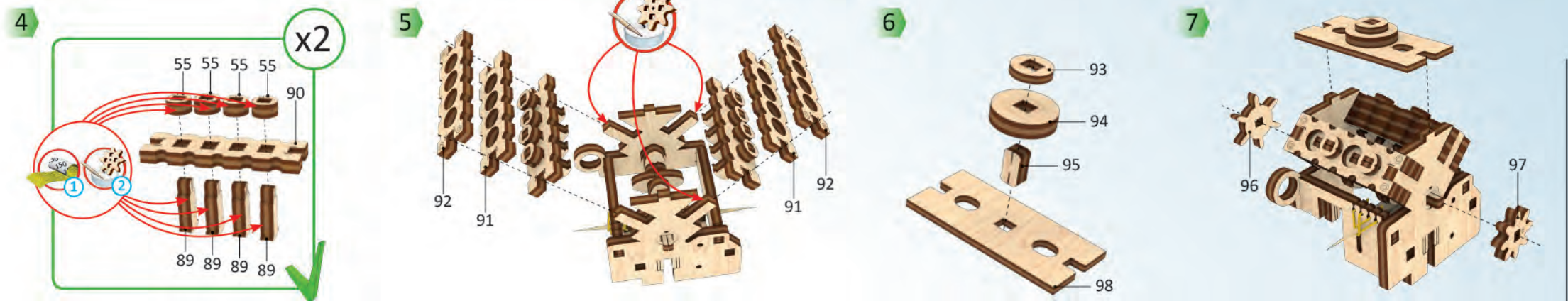
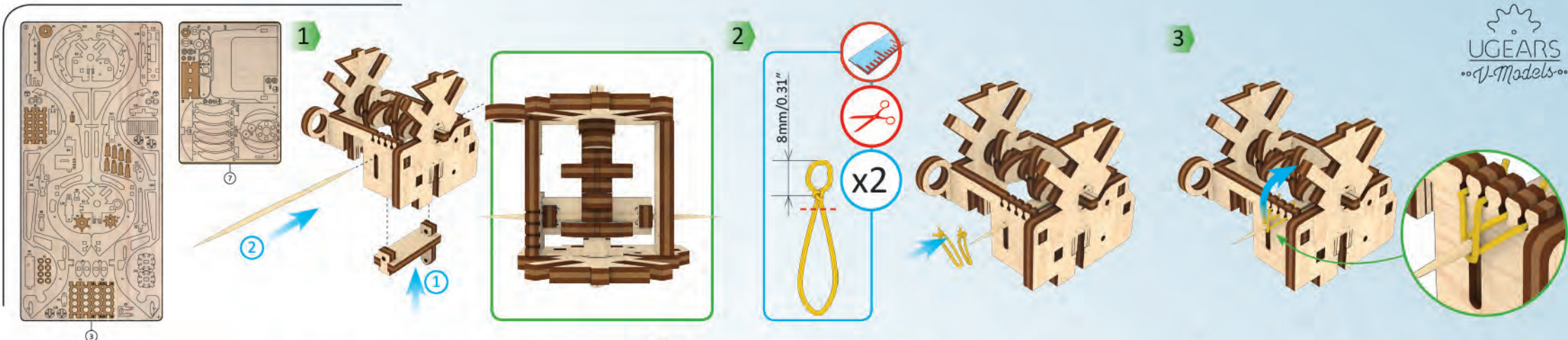

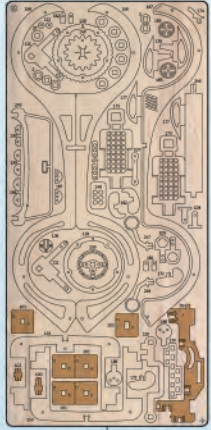

1

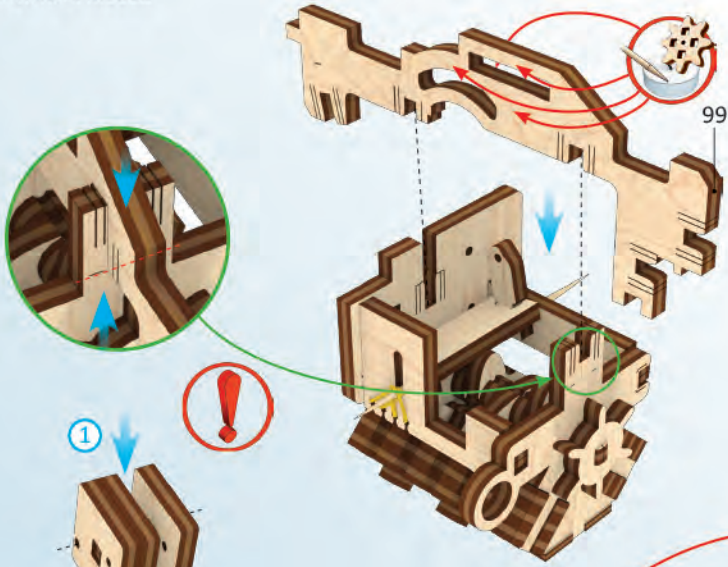

2

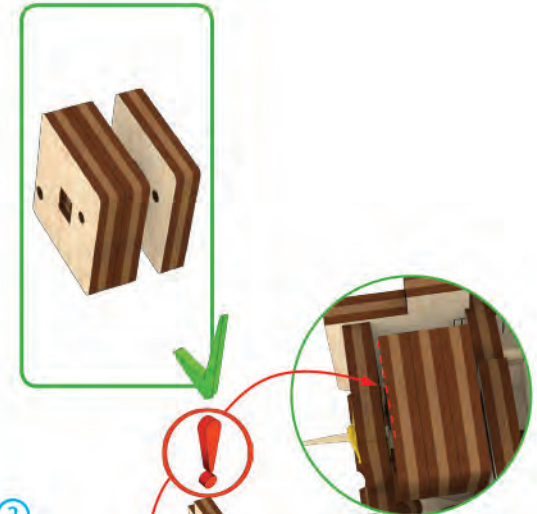
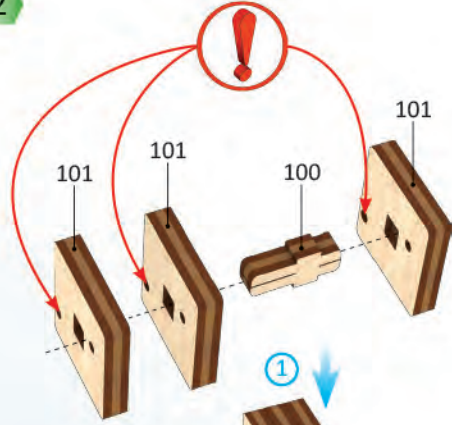

3

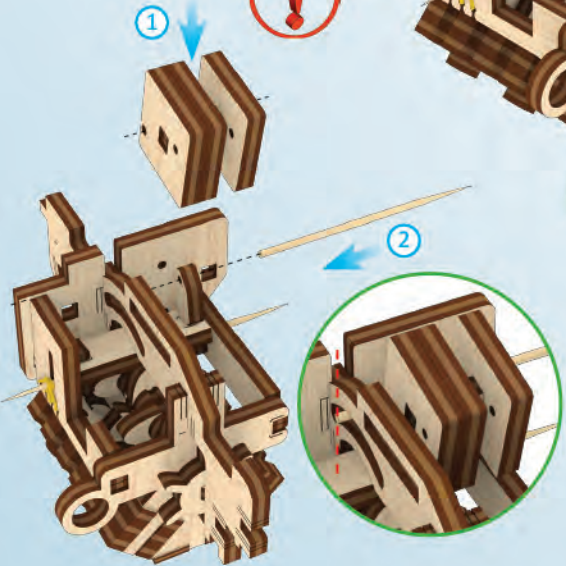
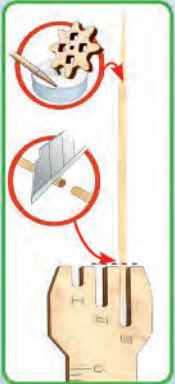

4

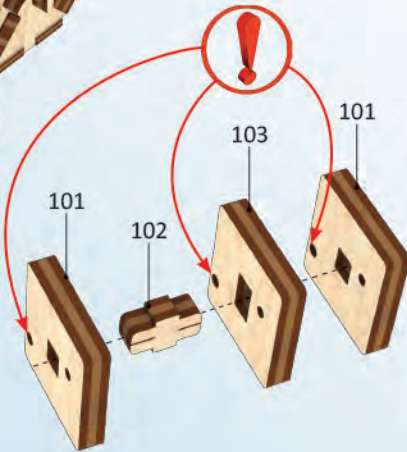

5



6

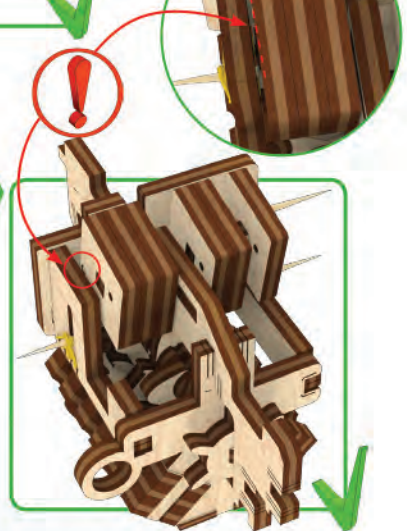

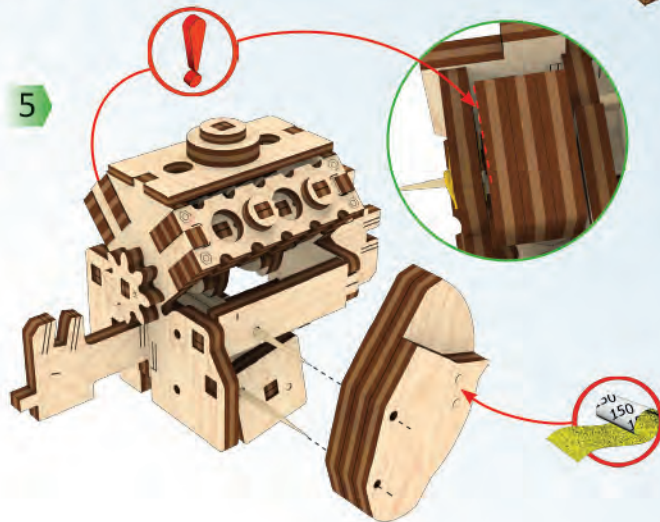
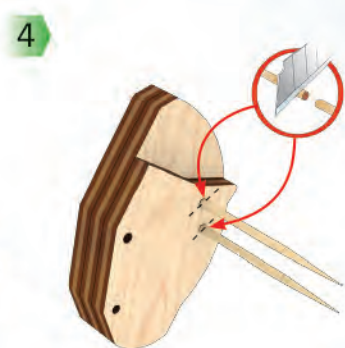
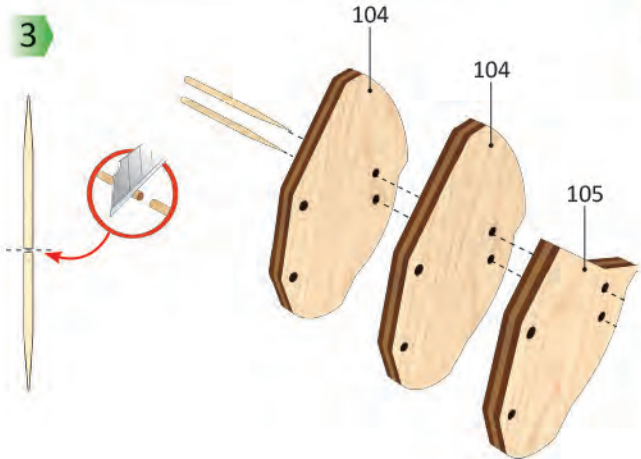
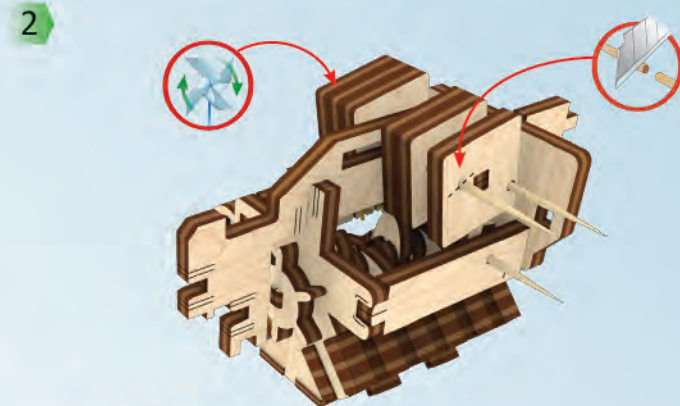
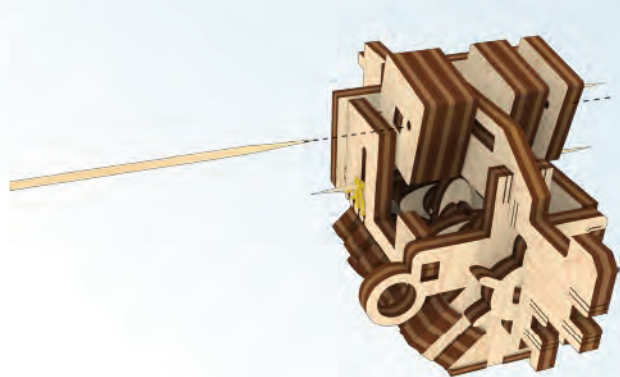
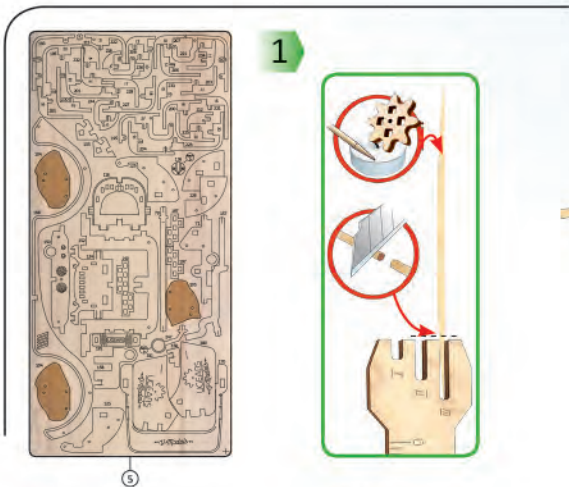

Mechanical models

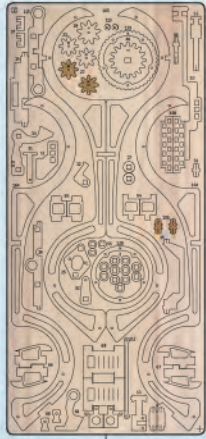

1

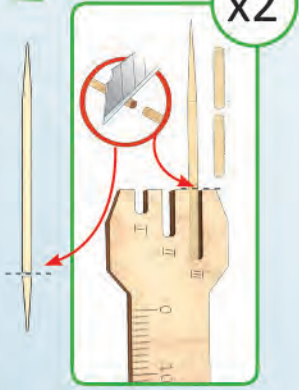

x2

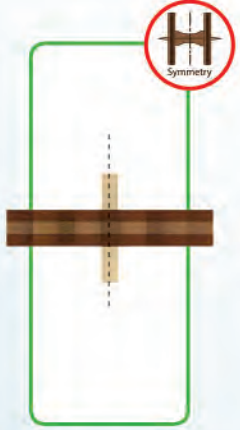

2

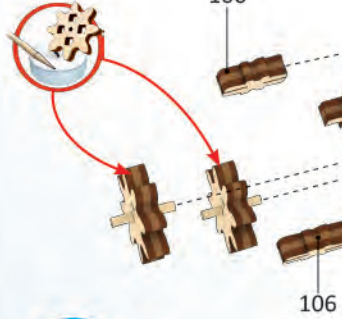

106

106

3

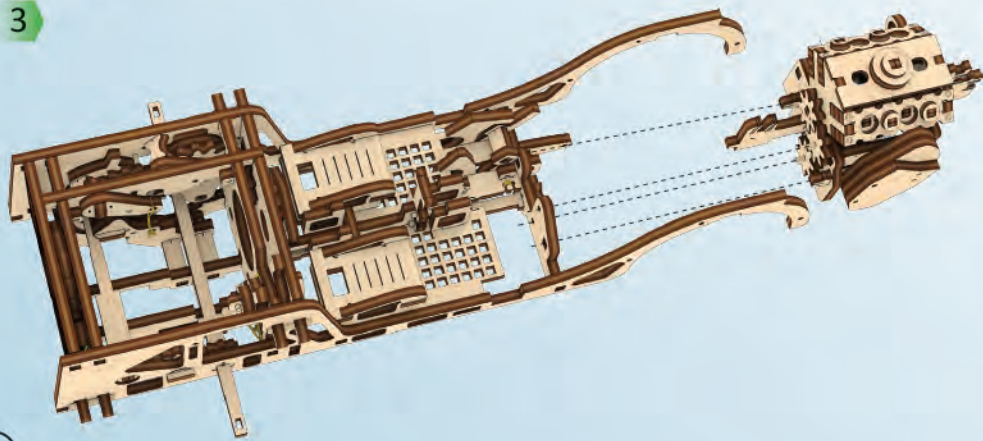

4

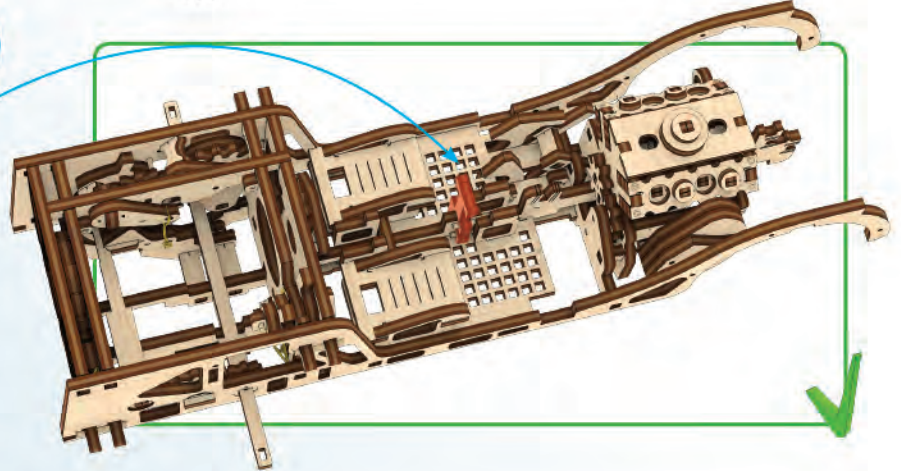
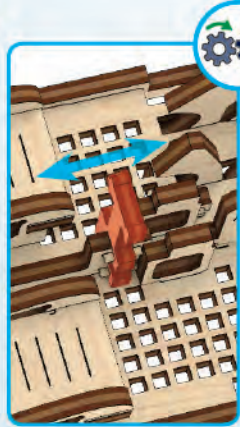

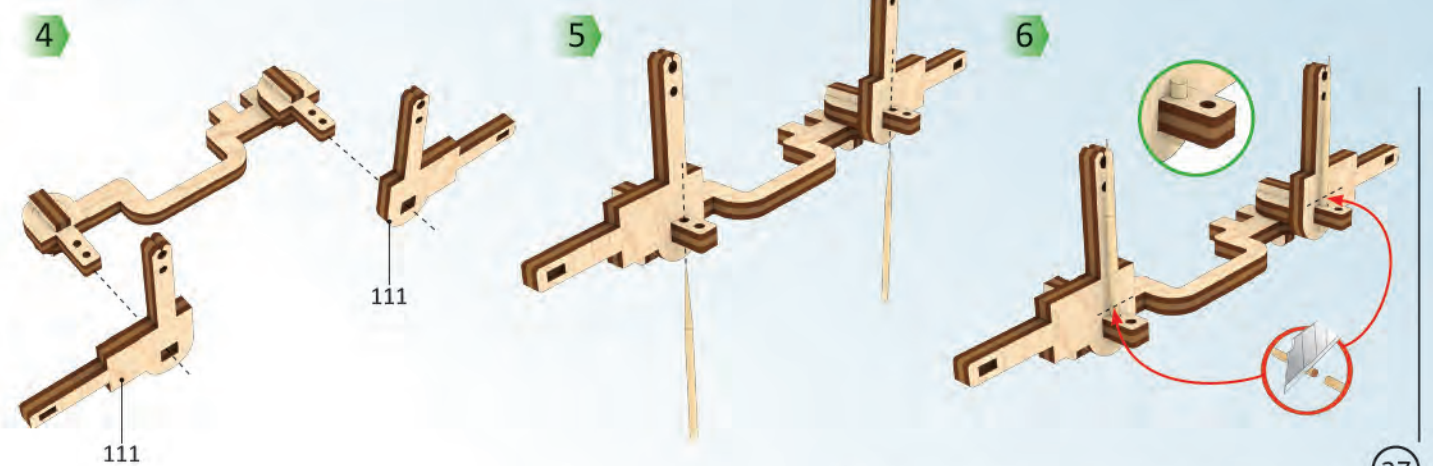
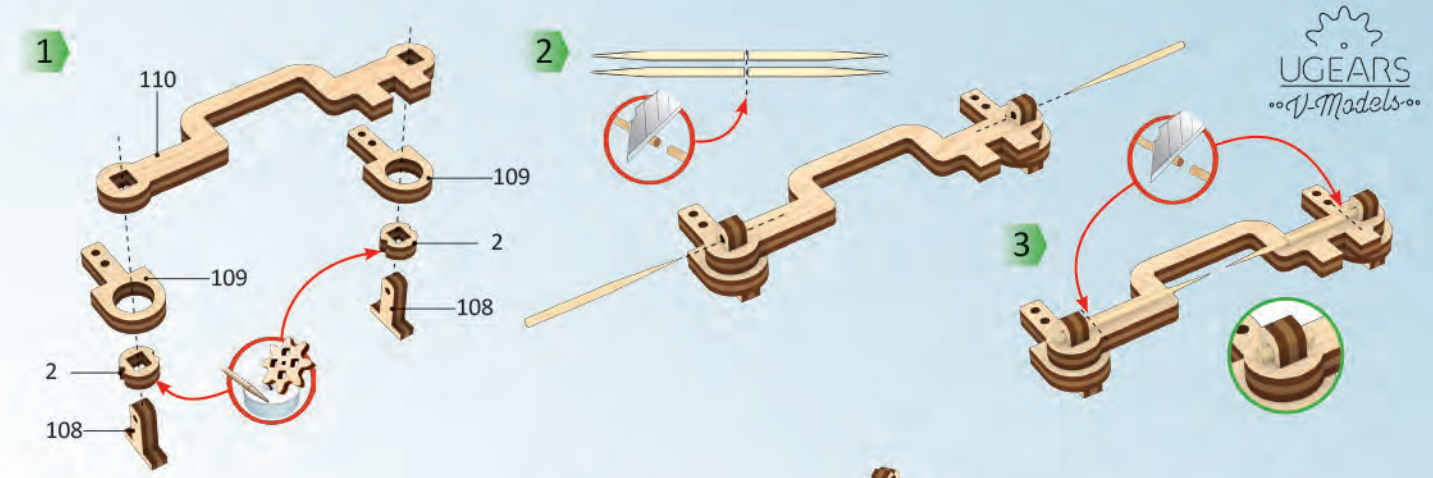
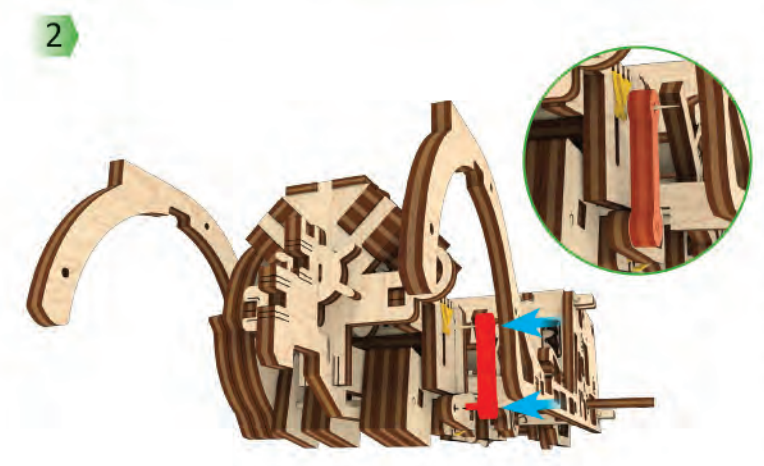
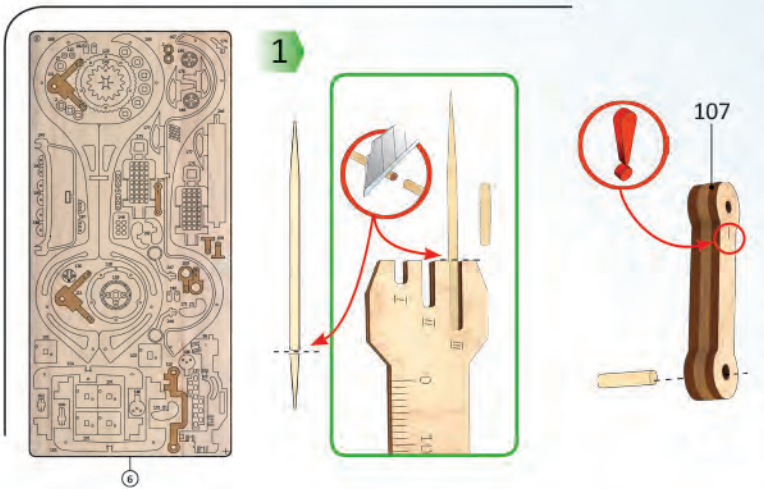

Mechanical models

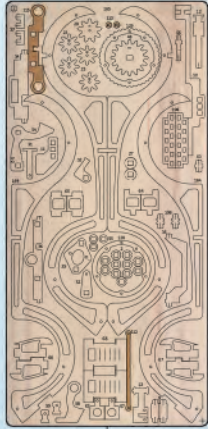

2

1

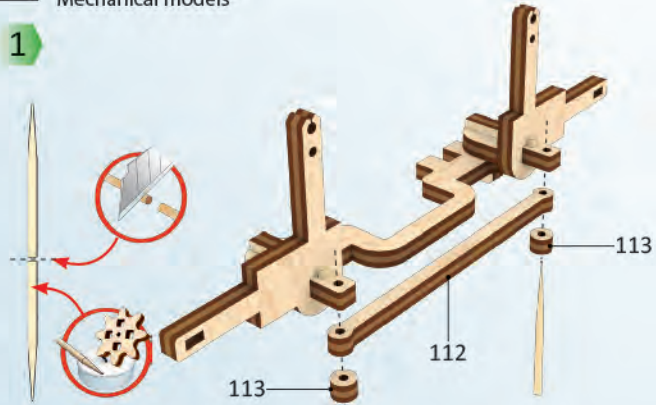

2

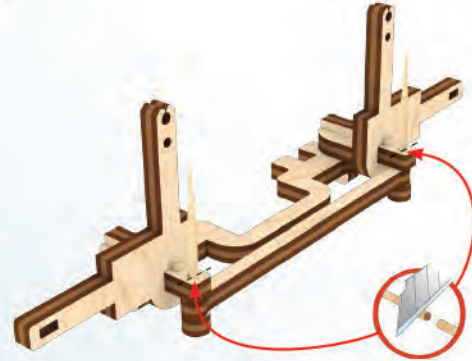

3

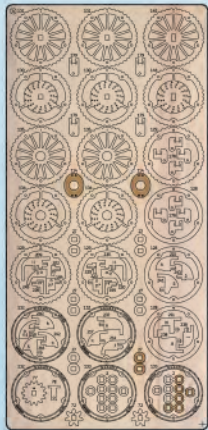
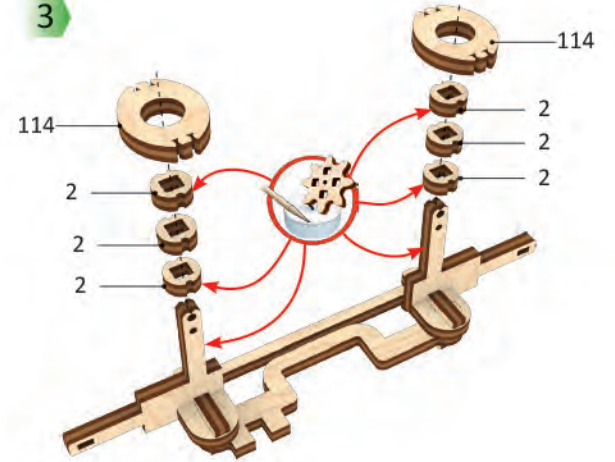

28

4

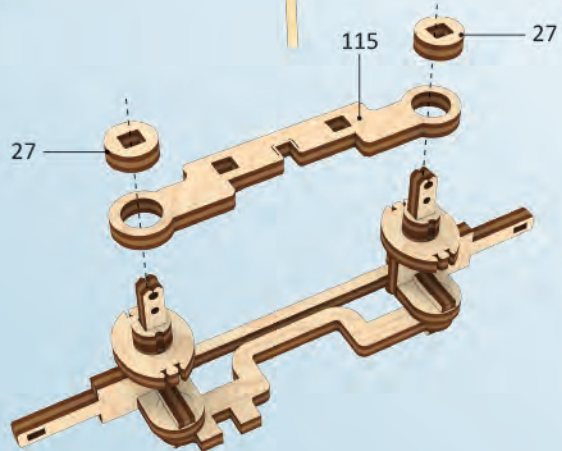

5



6

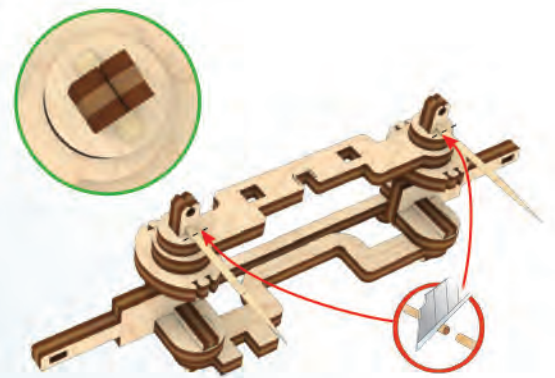

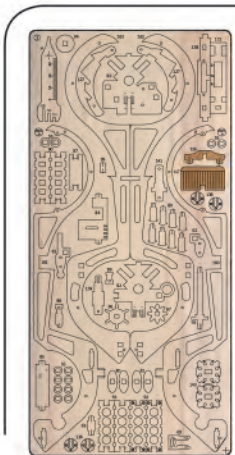

1

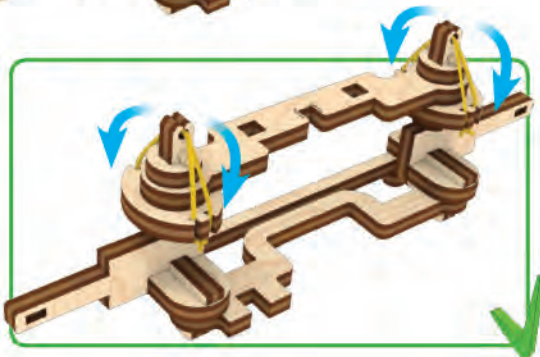
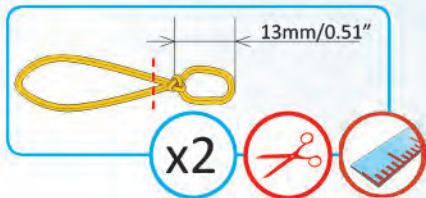

1

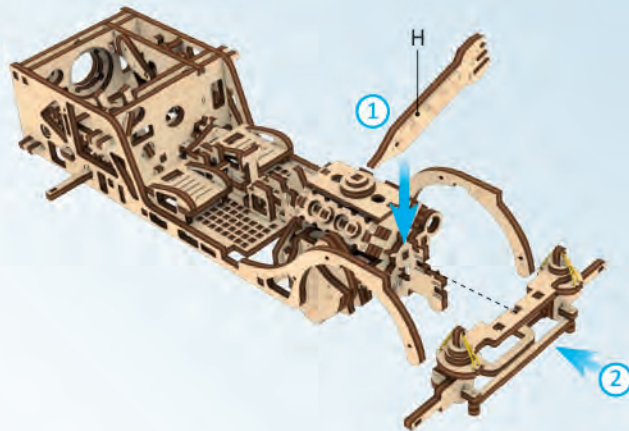

2

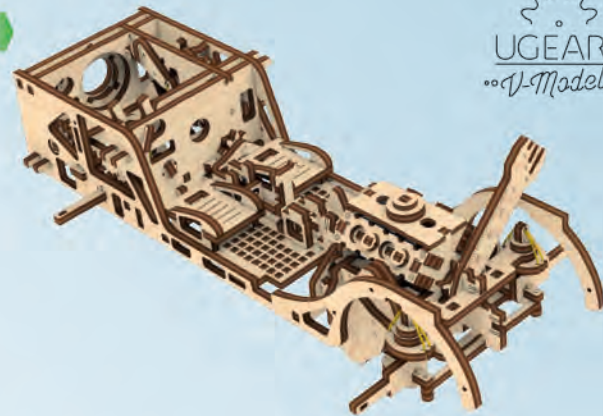

3

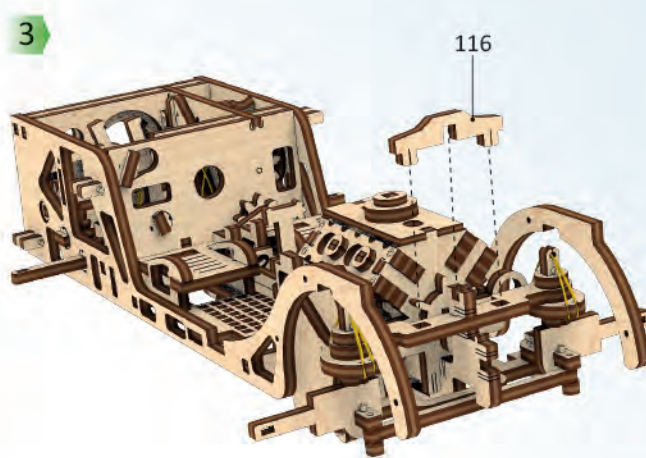

4

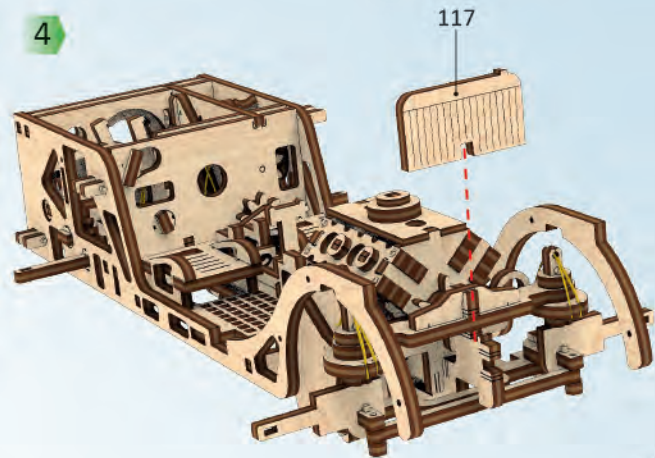

Mechanical models

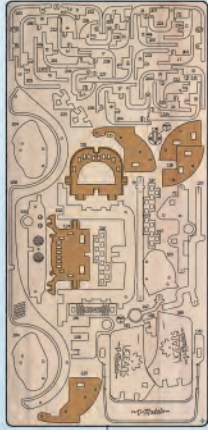

5

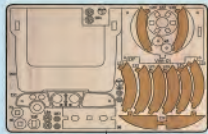
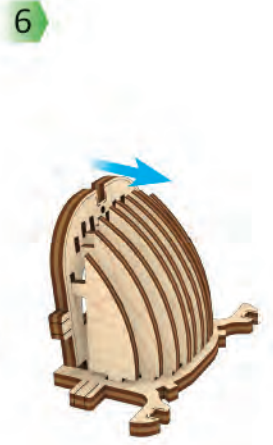
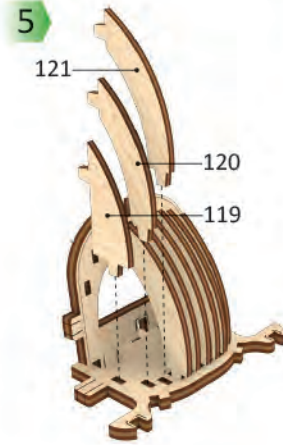
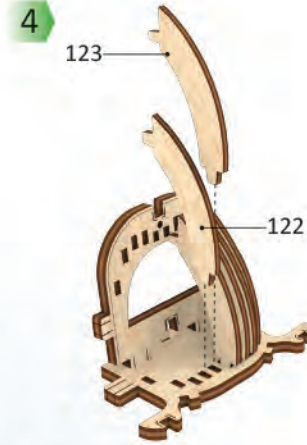
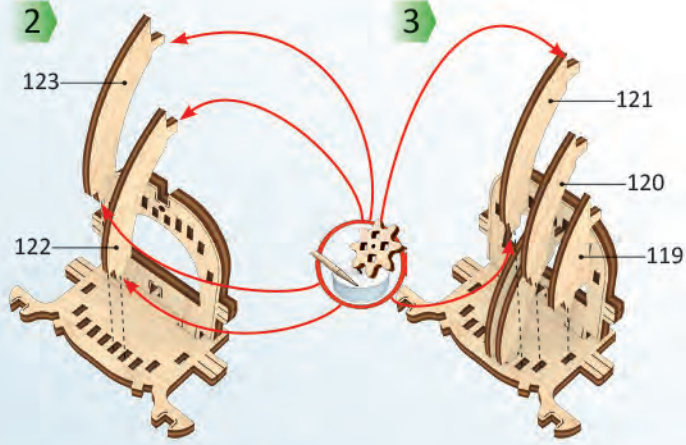
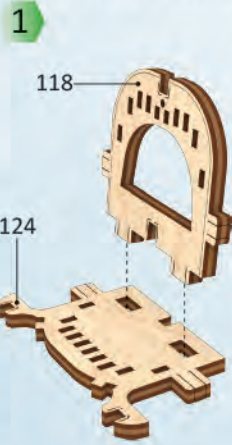

7

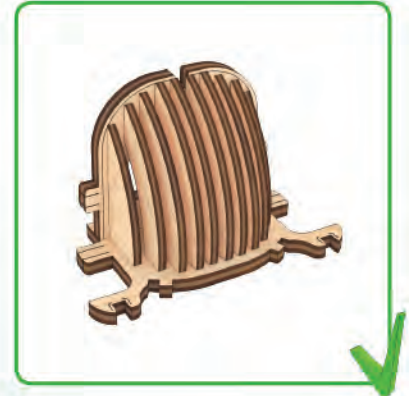
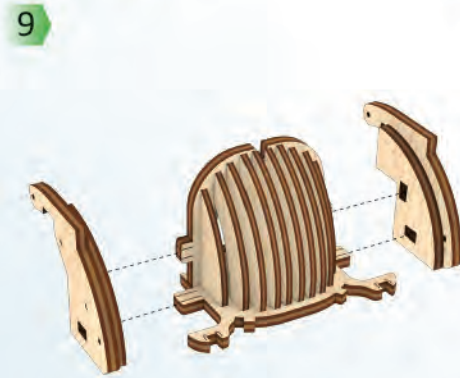
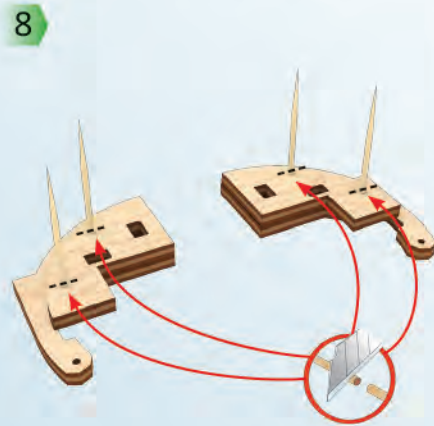



1



2

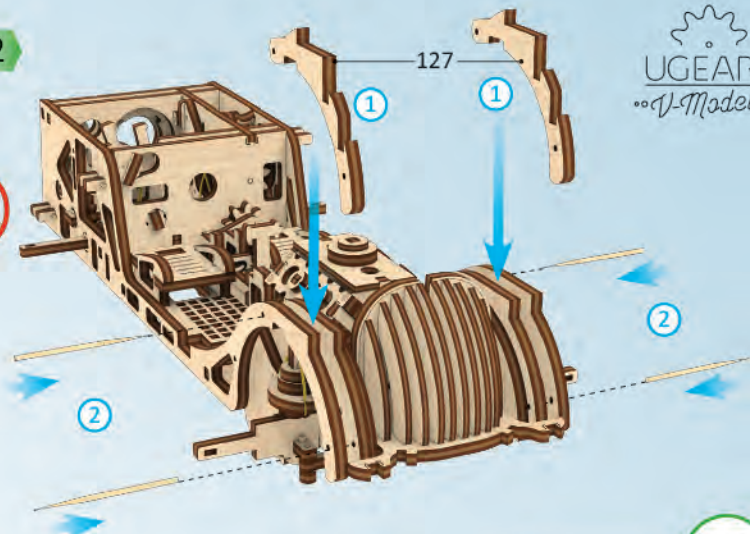

3

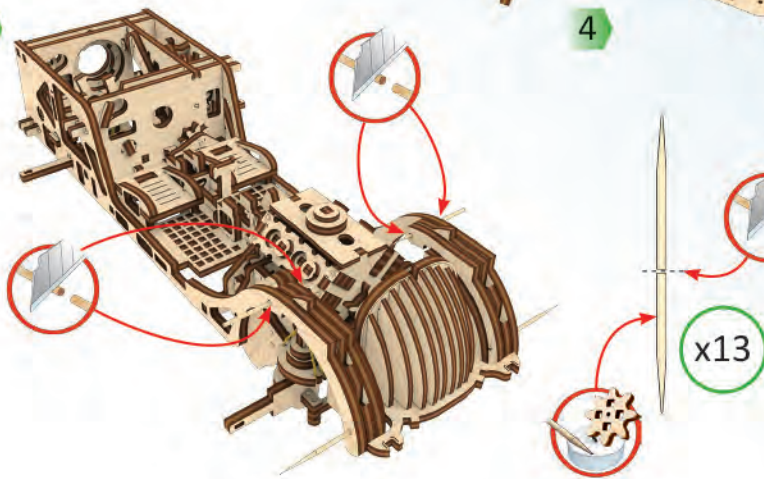

4

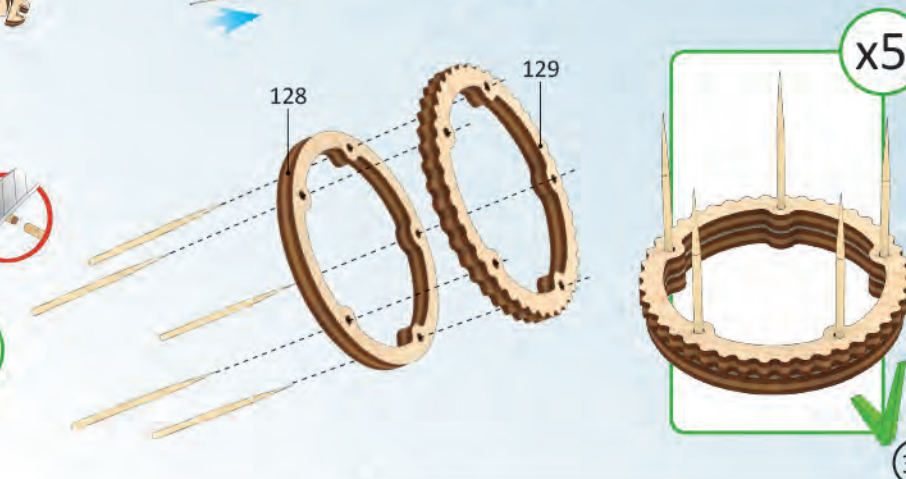

4

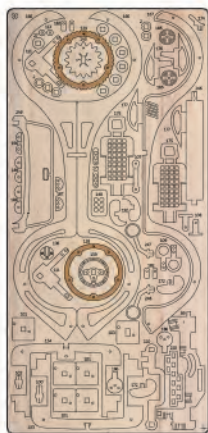

5

Mechanical models



1

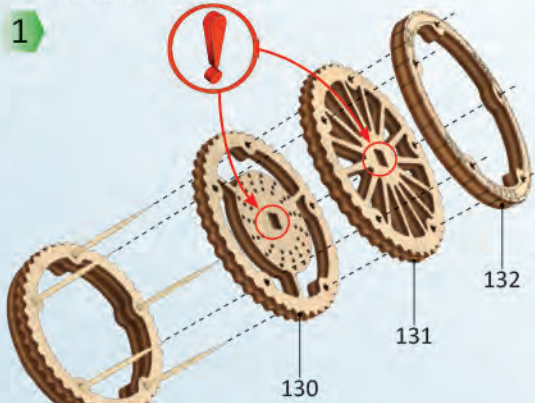

2



3

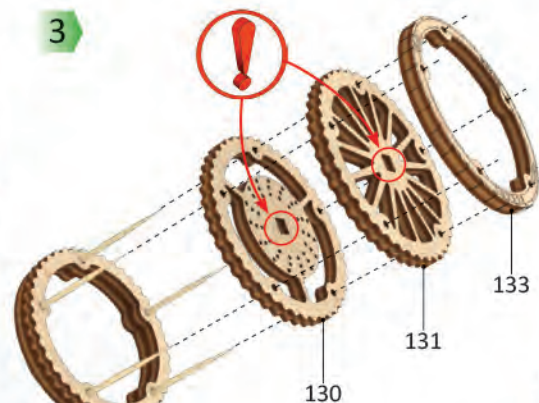

4

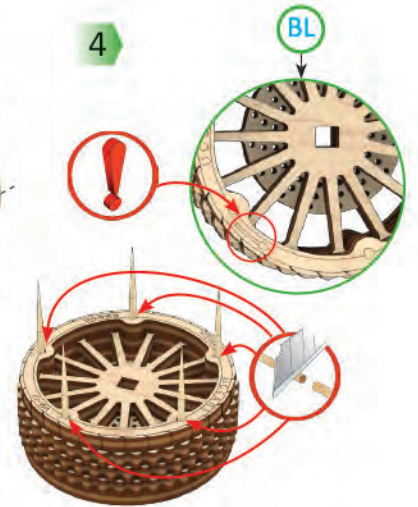

5

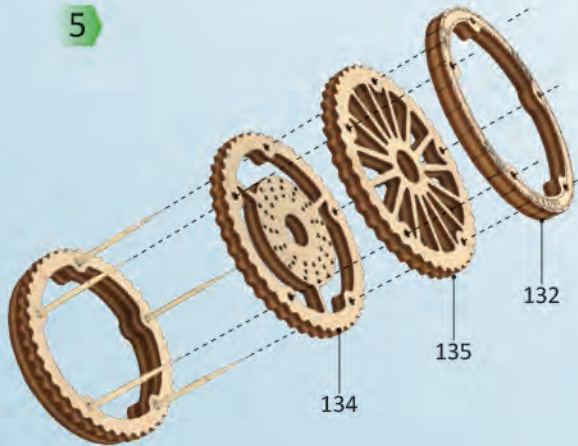

5



7

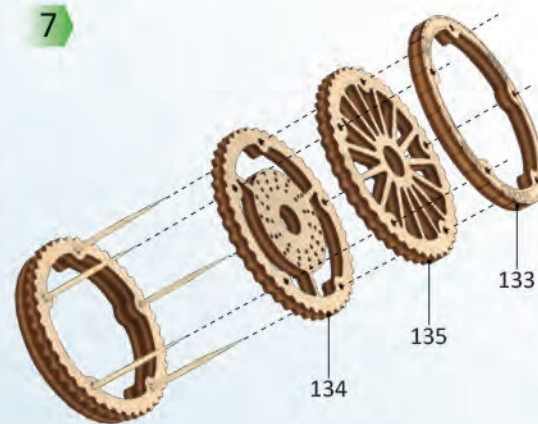

8



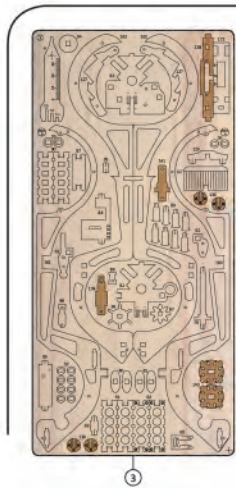

1

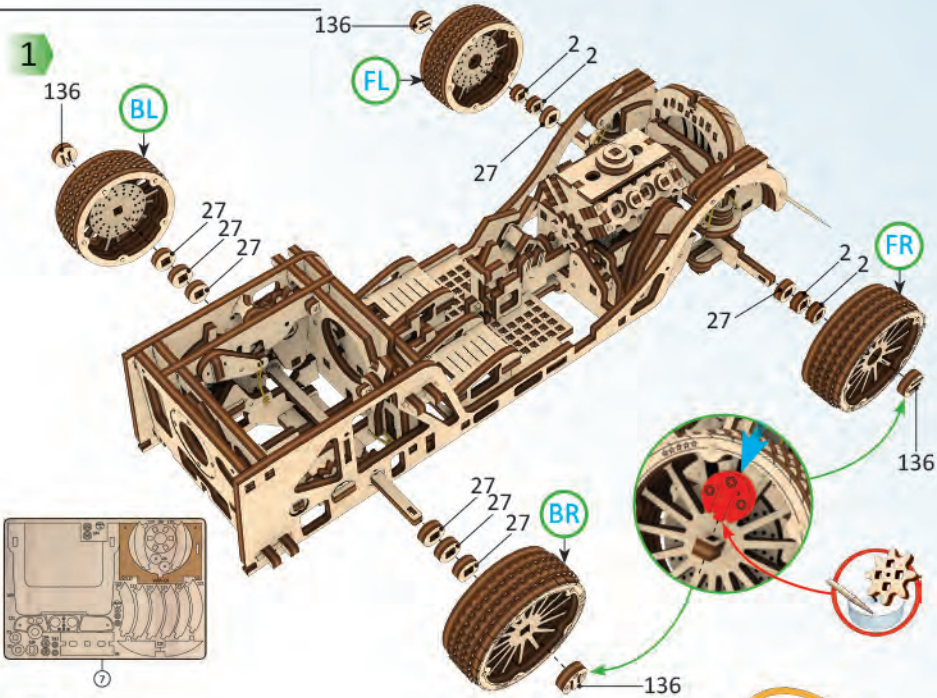

2

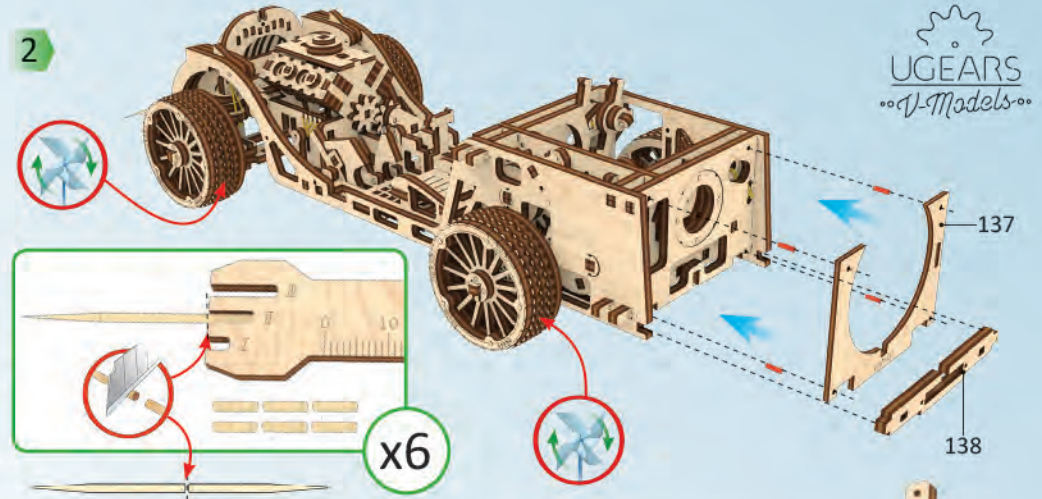

3

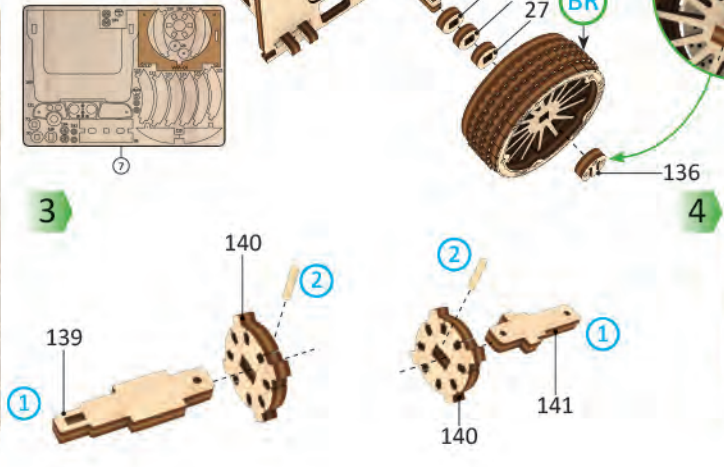

4



4

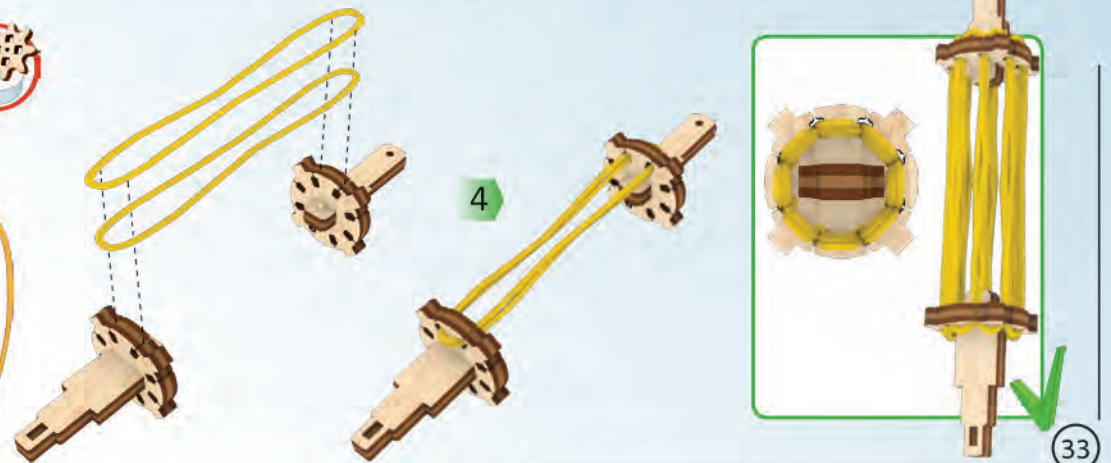

Mechanical models

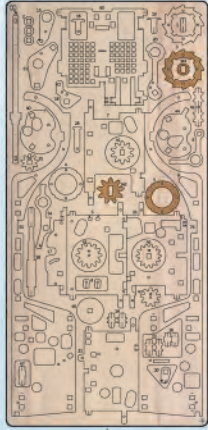

1

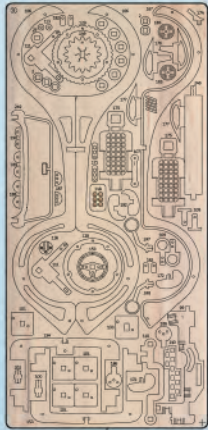
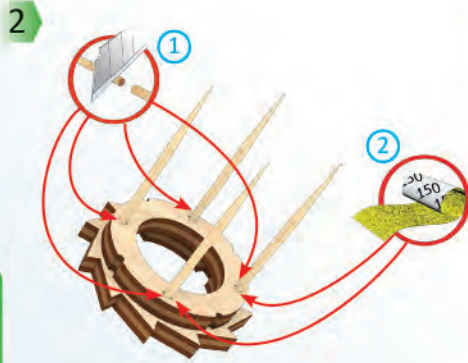
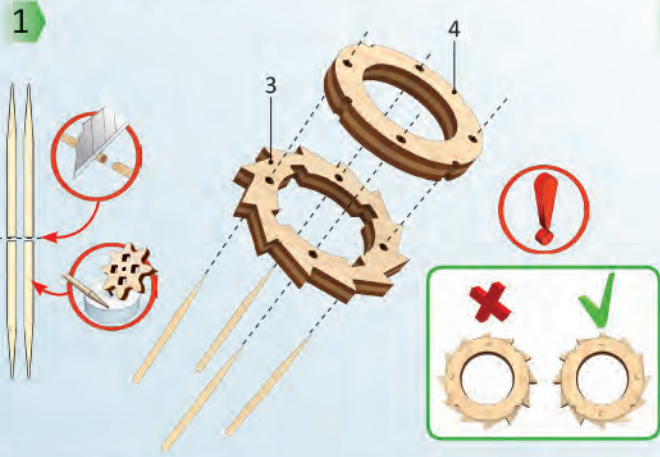

6

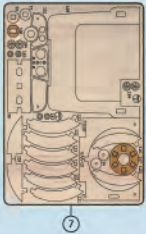

7

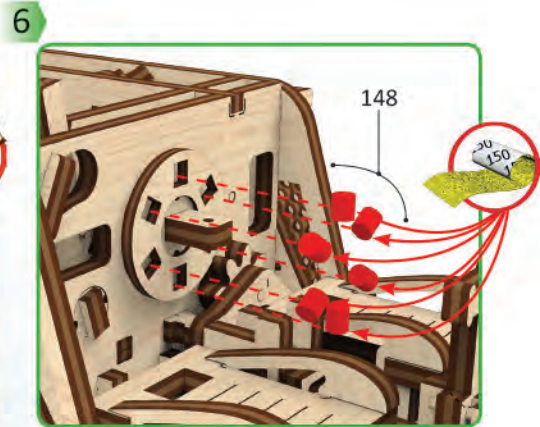
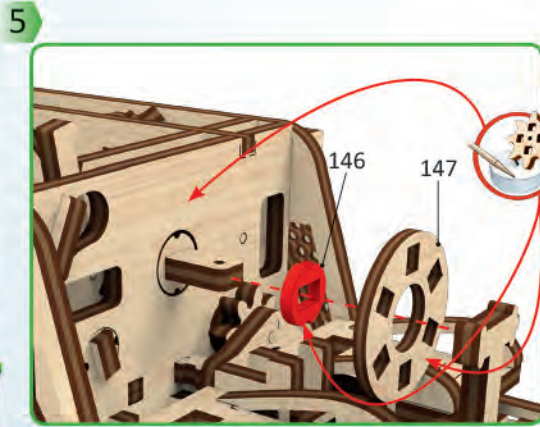
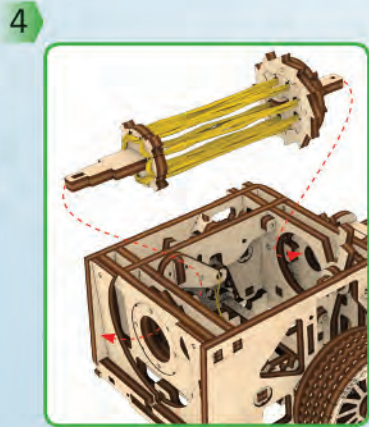



7

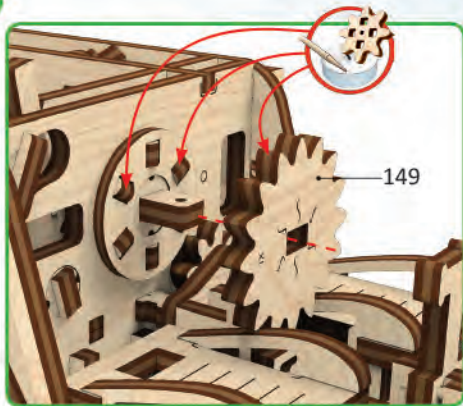

8

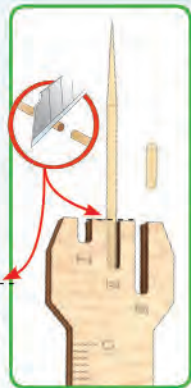

9

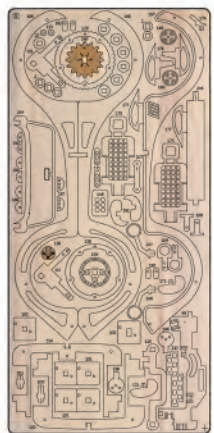
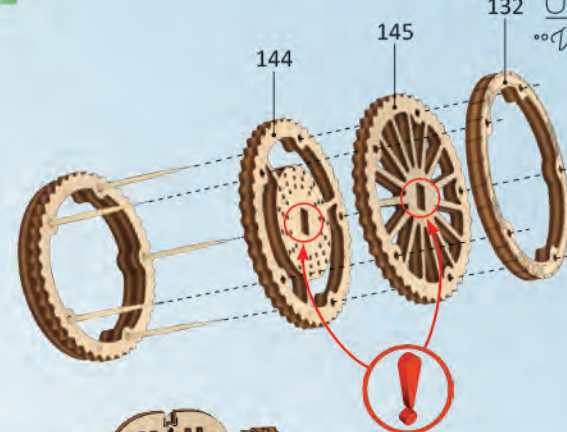

10

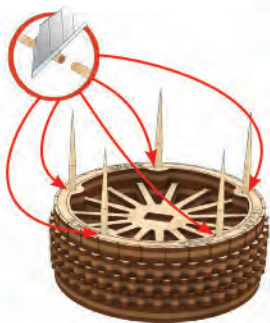

11

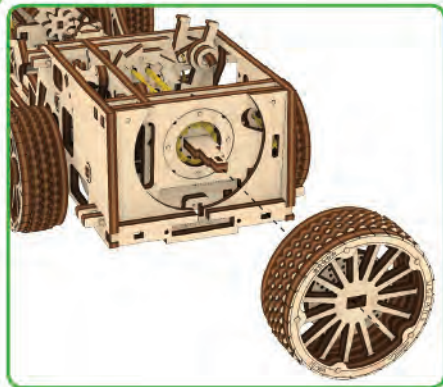

12

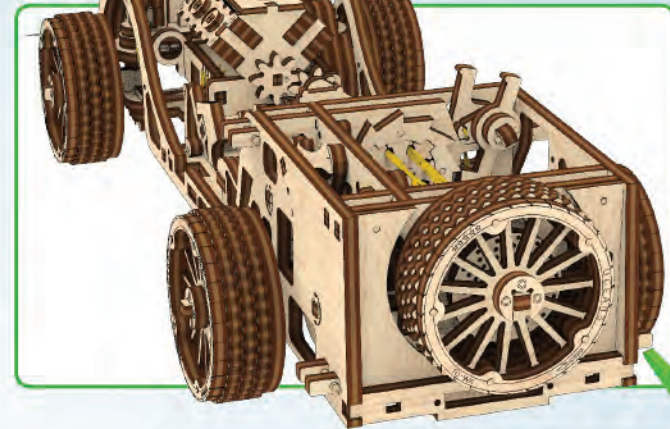
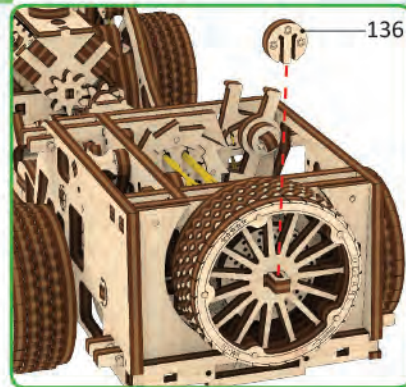

Mechanical models



5

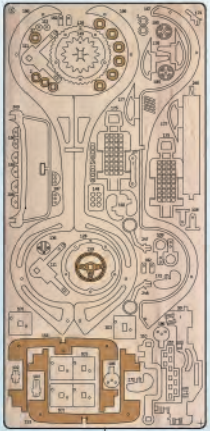

6

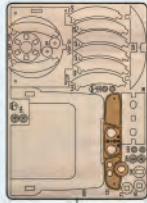

7

1

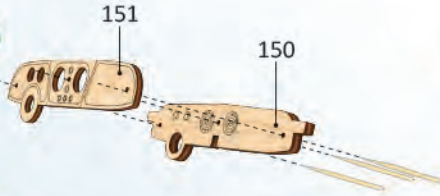

2

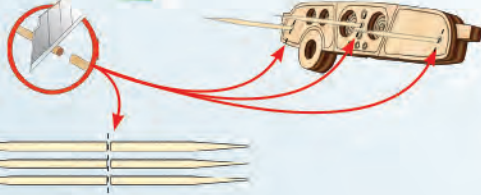

3

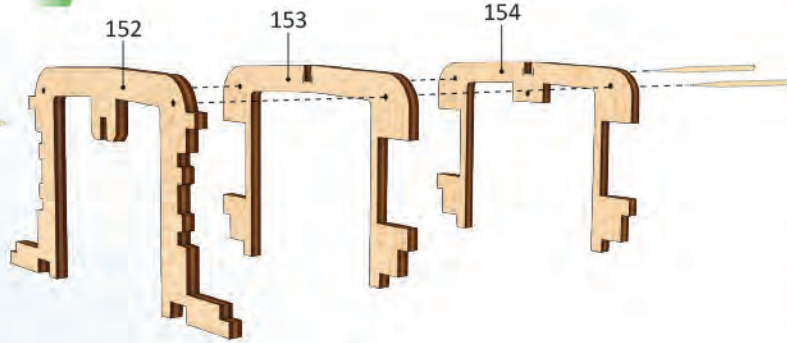

4

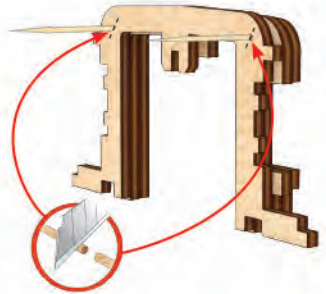

5

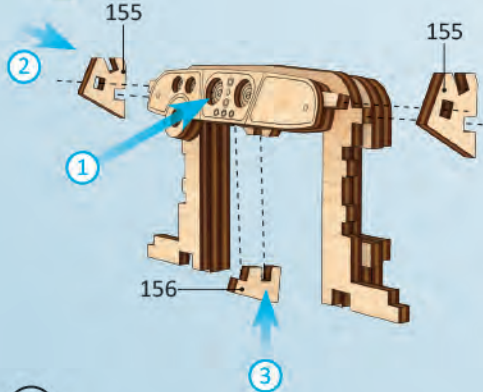

6

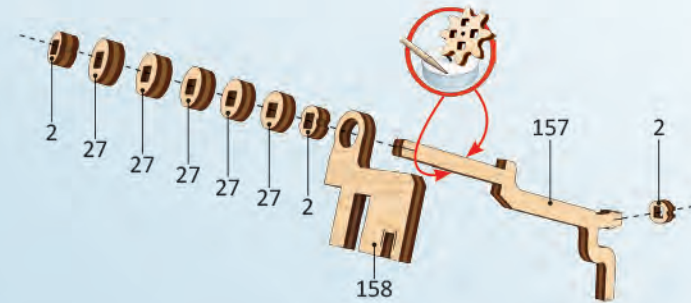

7

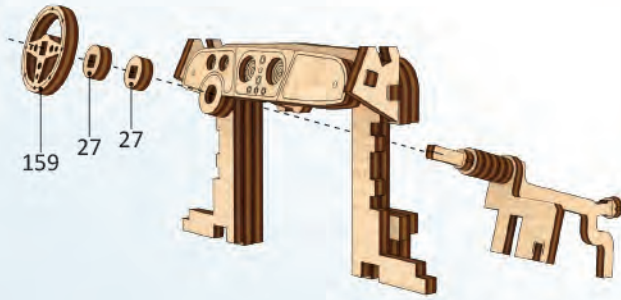

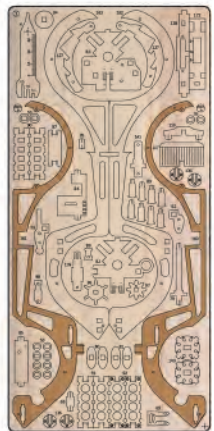

1

$\frac{3}{4}$

x6

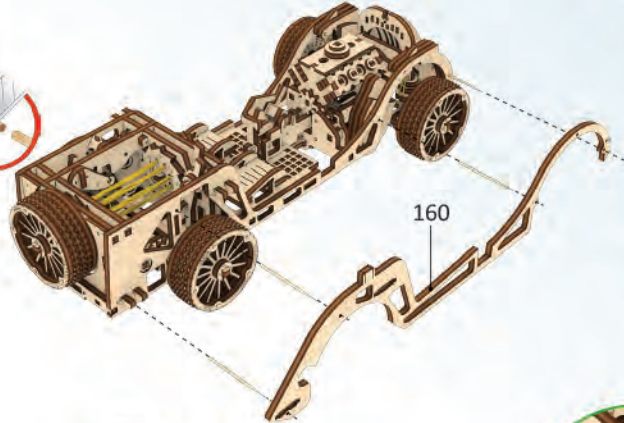

160

2

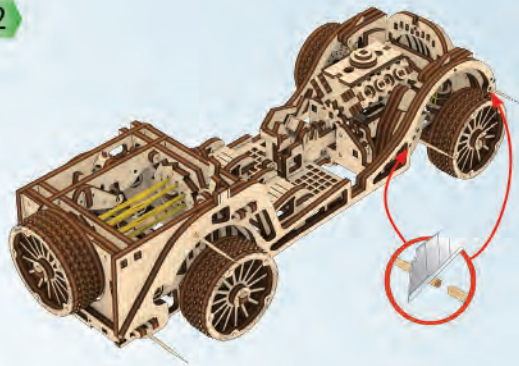

3

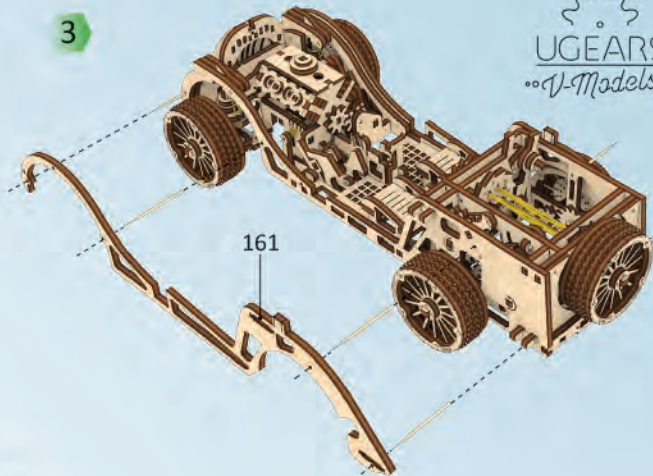

161

4

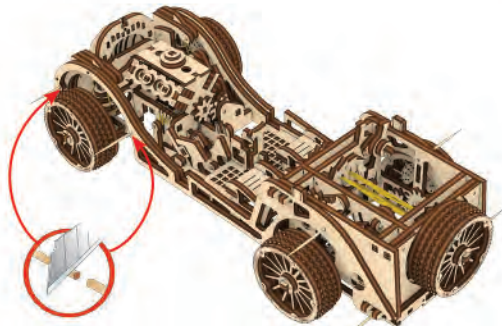

5

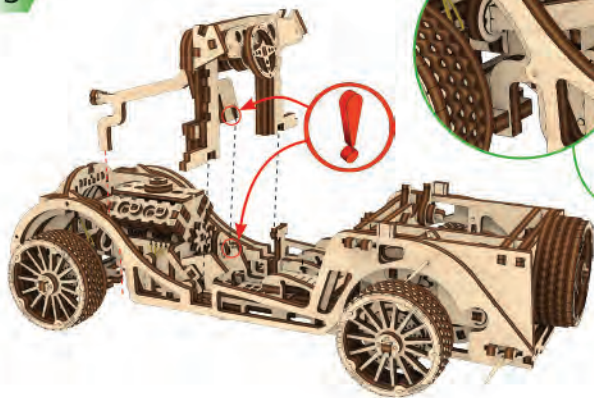

6



$\frac{3}{4}$

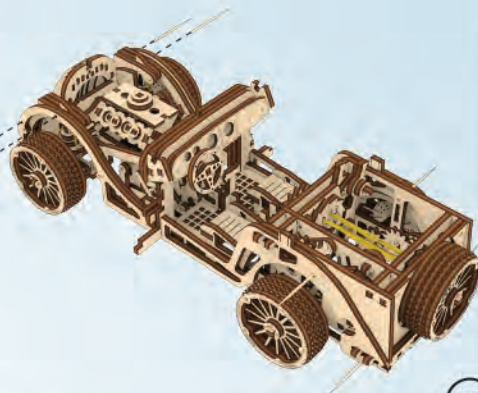

Mechanical models

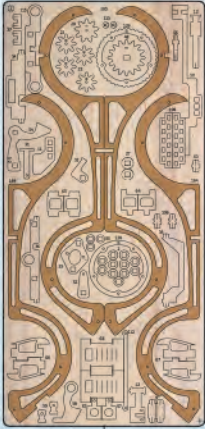

2

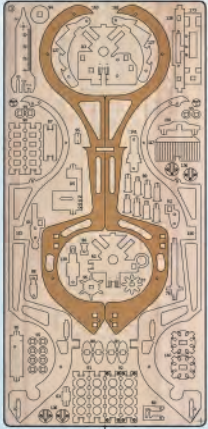

3

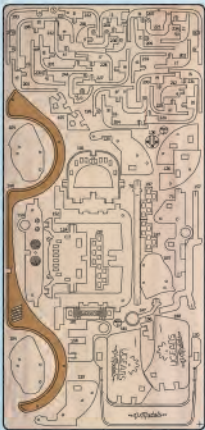

5

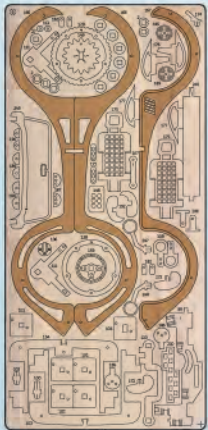

6

38

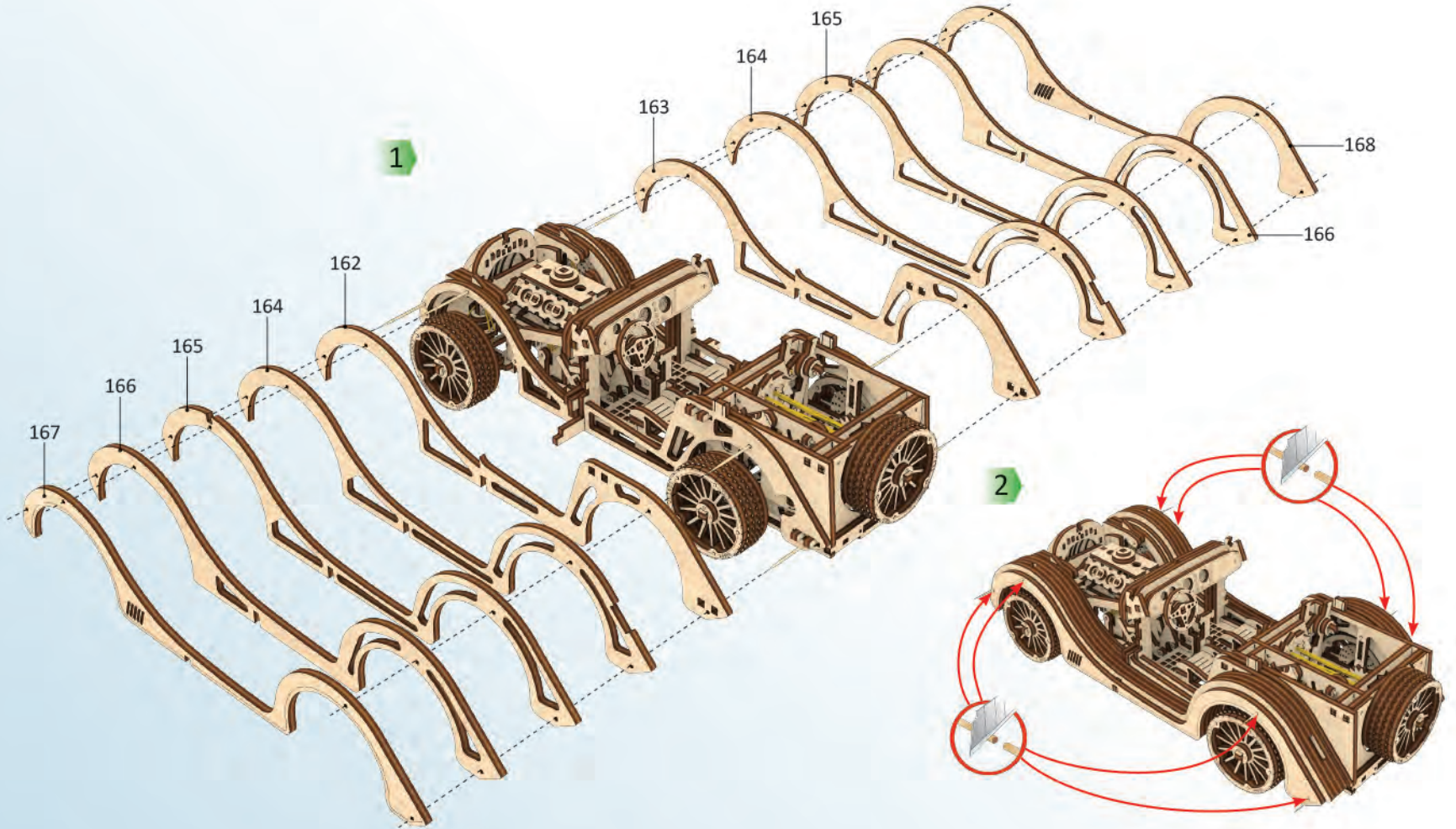

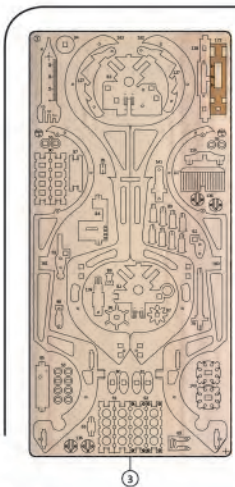

1

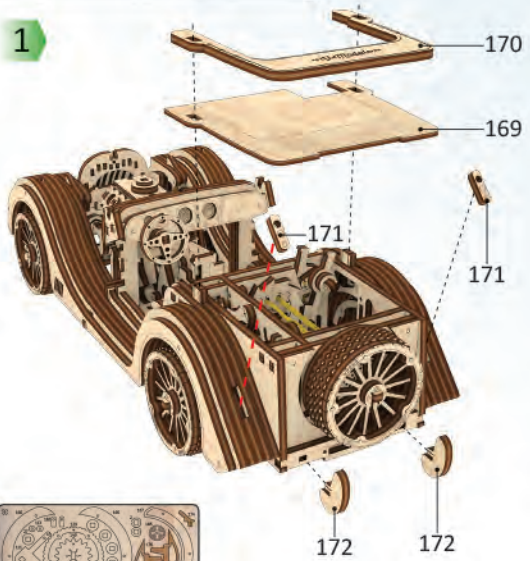

2

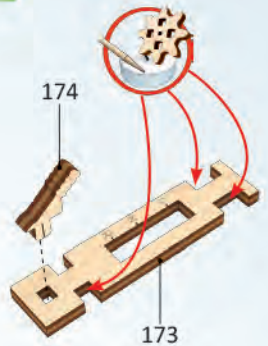

3

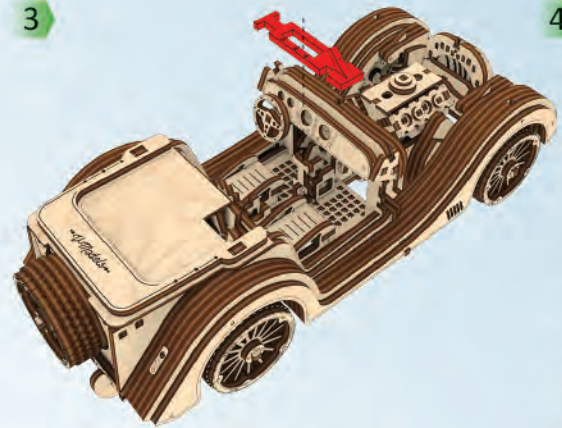

4

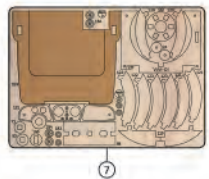
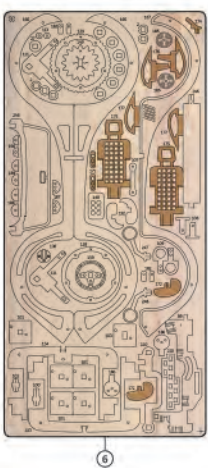
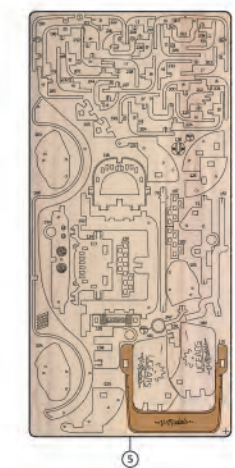
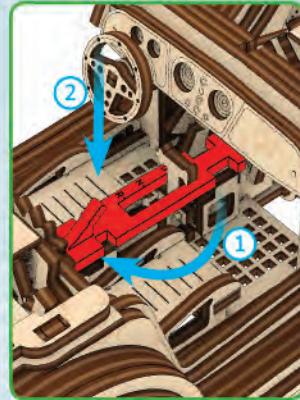

5

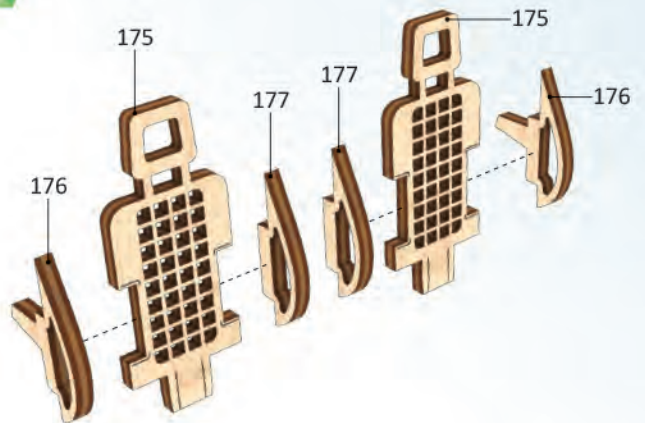

6

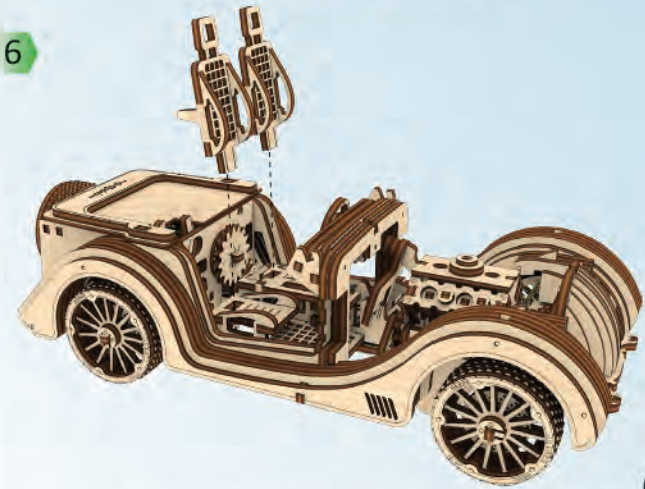

Mechanical models

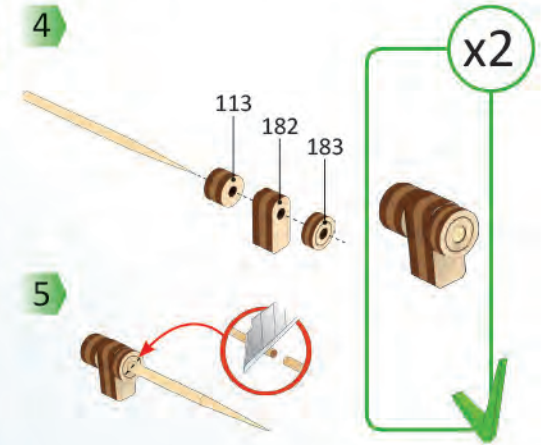
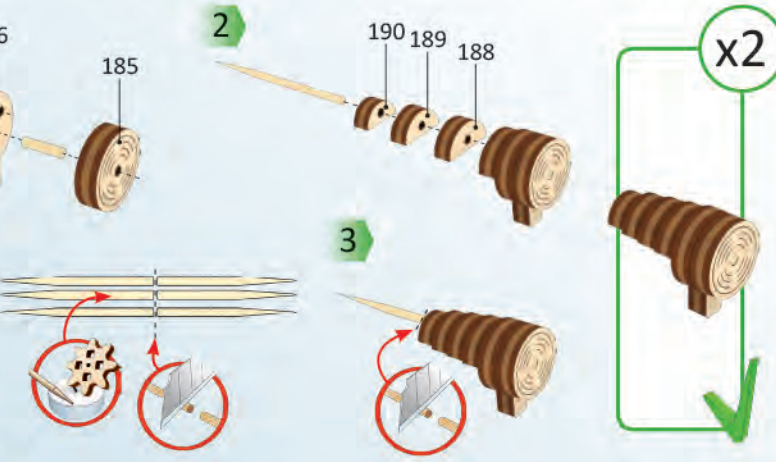
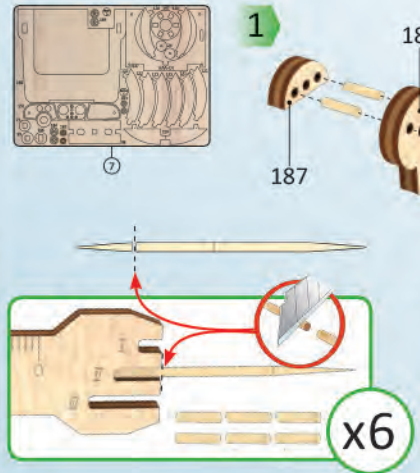
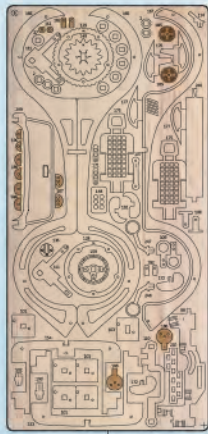
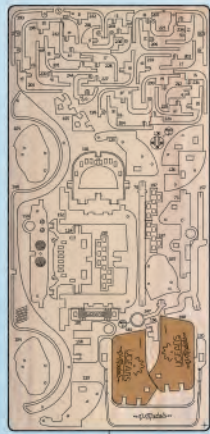
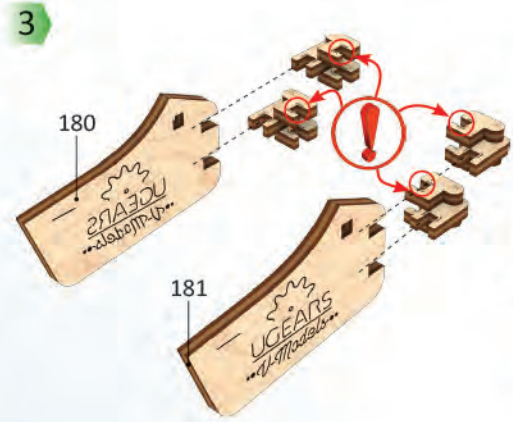
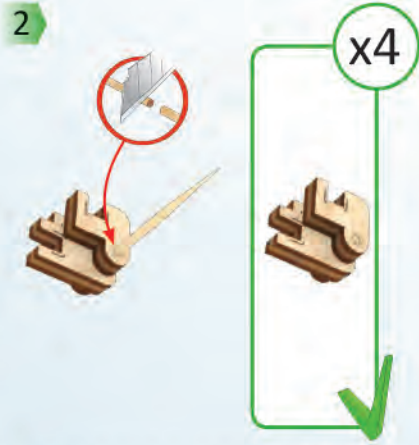
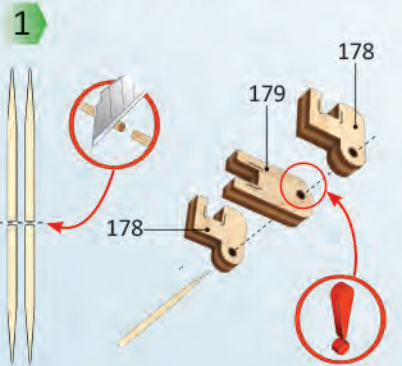
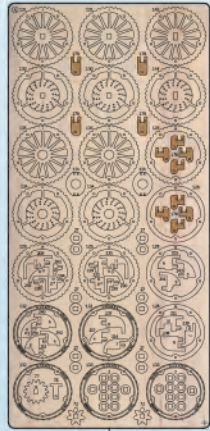

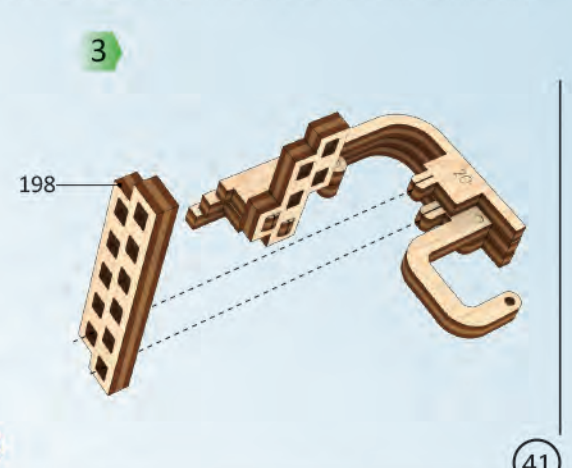
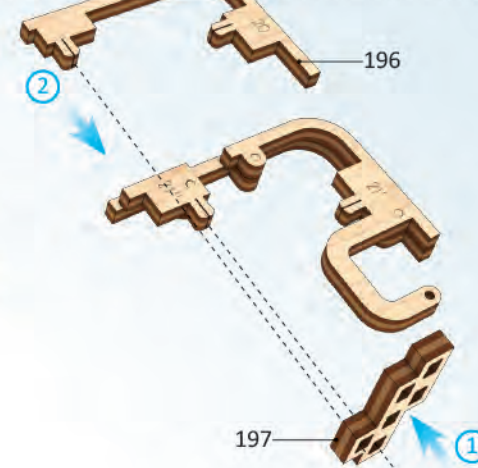
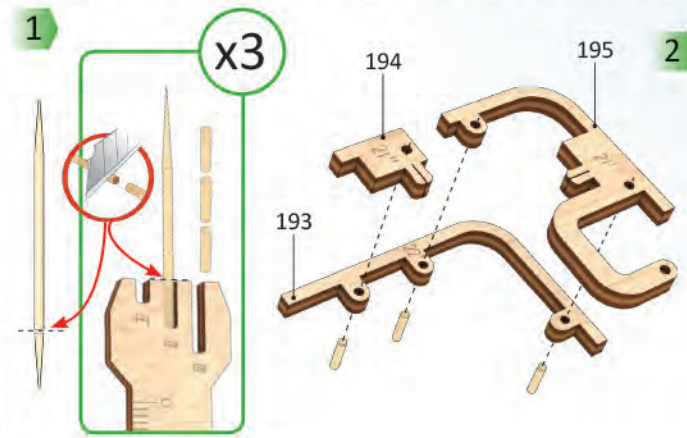
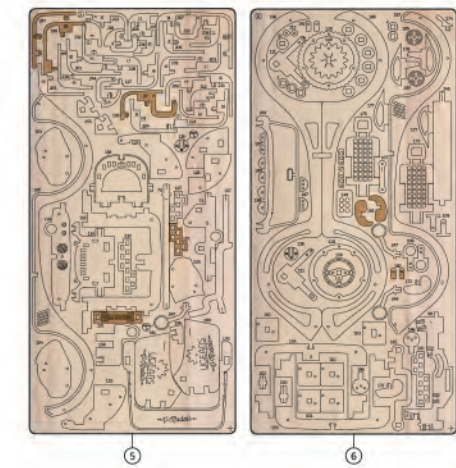
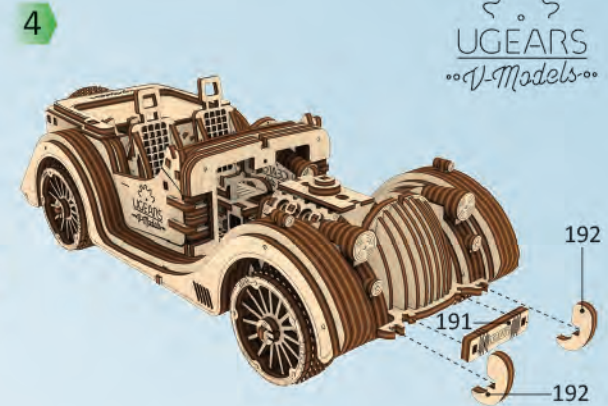
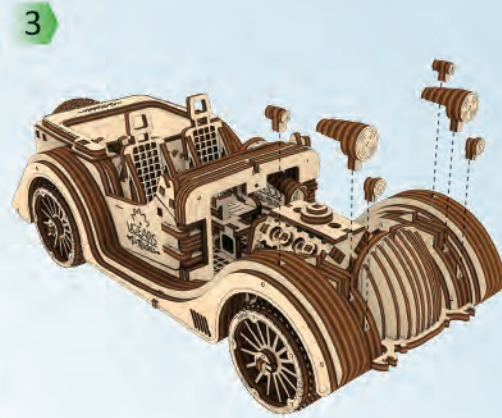
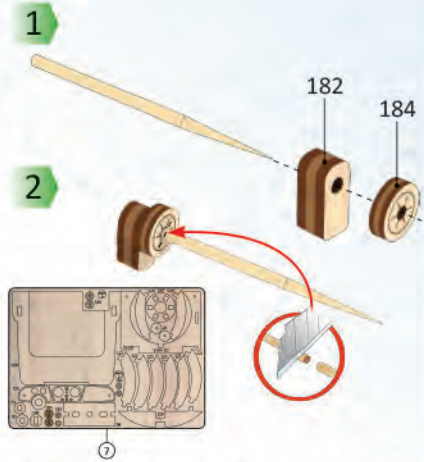
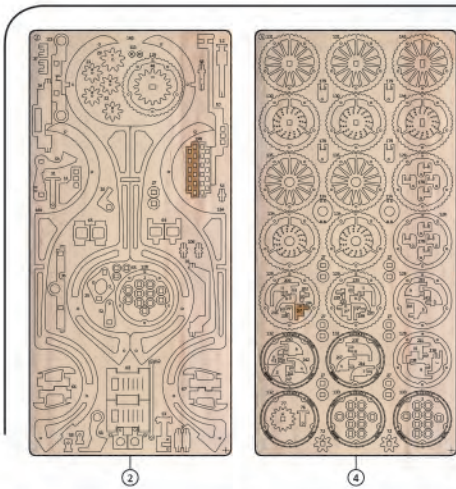

Mechanical models



4

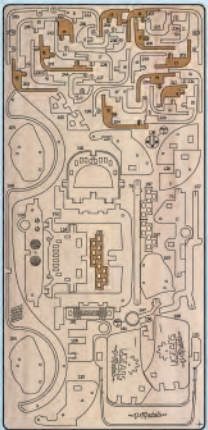

5

1

199

200



2

201



3

202

203



4

204



5

205

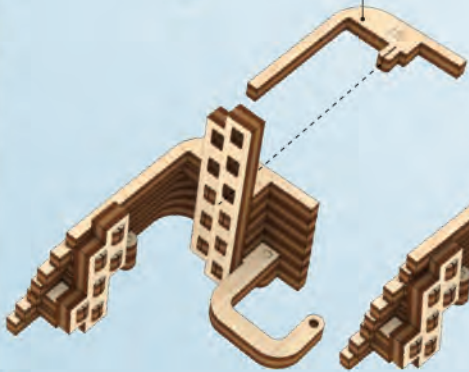

6

207



7

209



8

211



9

213

212



210



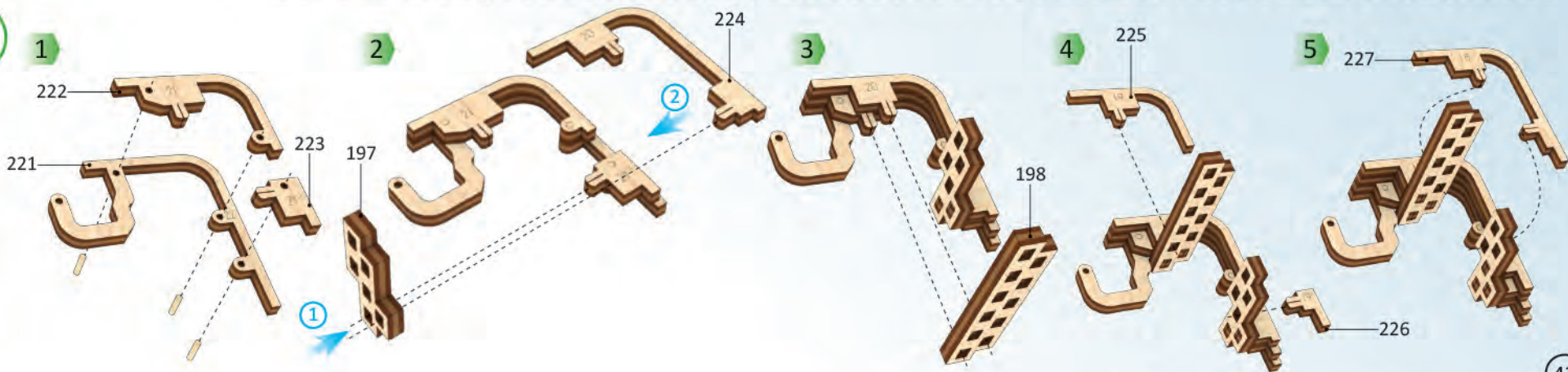
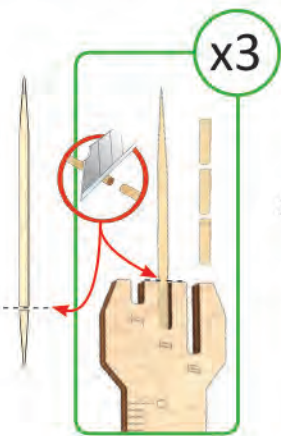
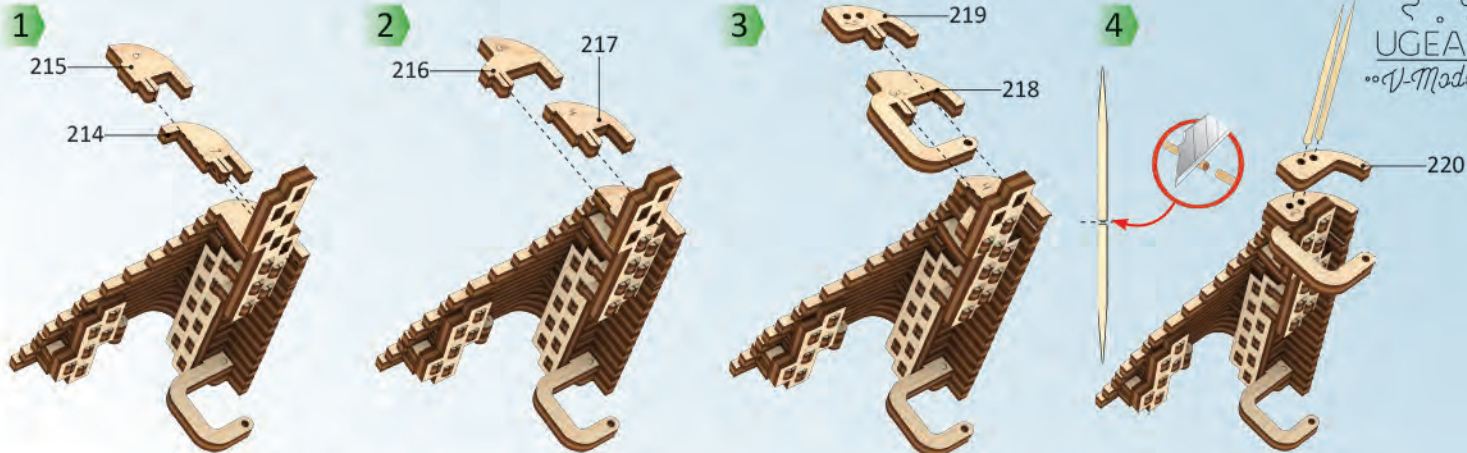
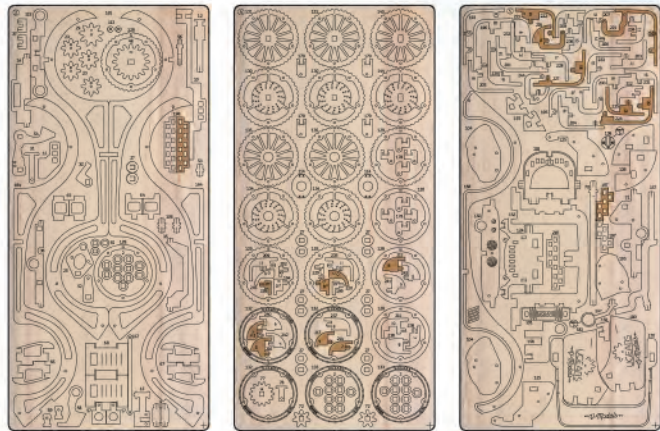

Mechanical models

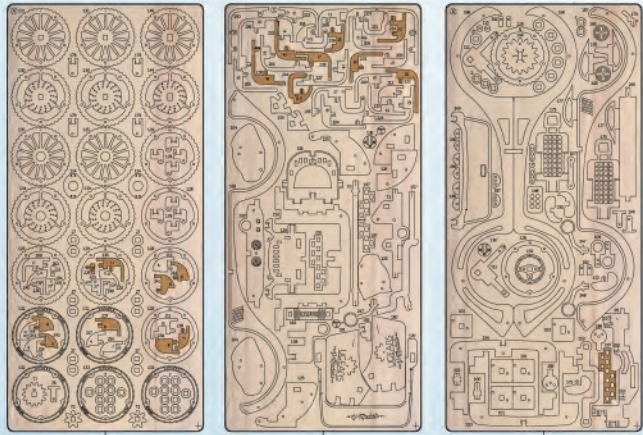

1

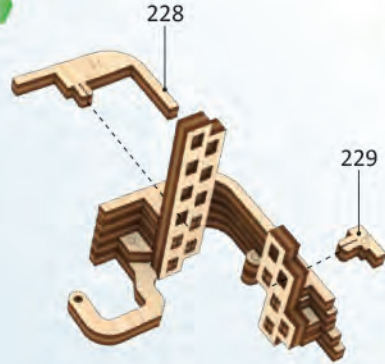

2



3



4

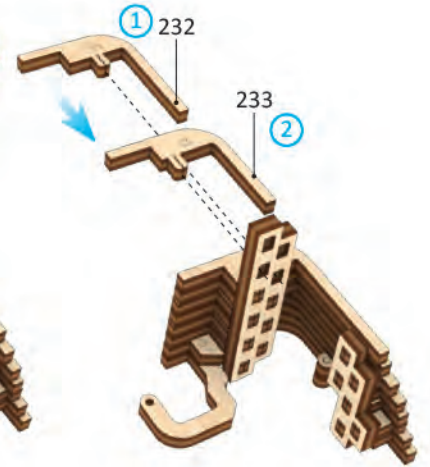

5

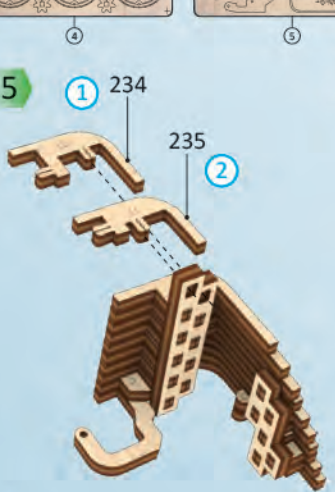

6

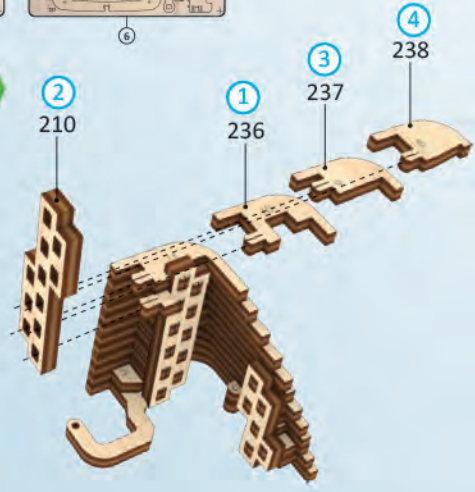

7

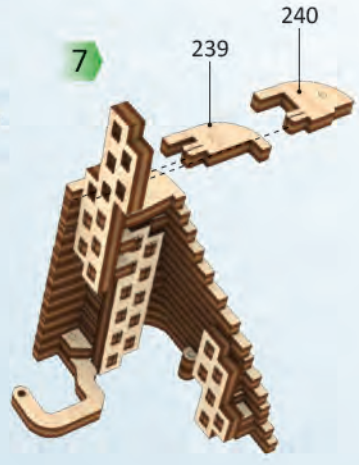

8

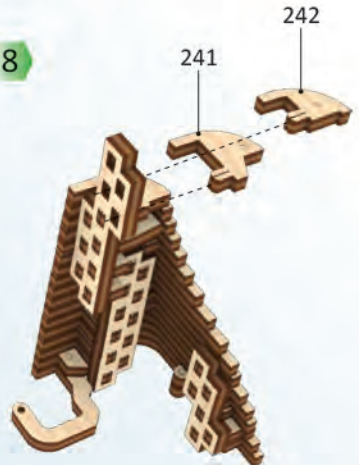

9

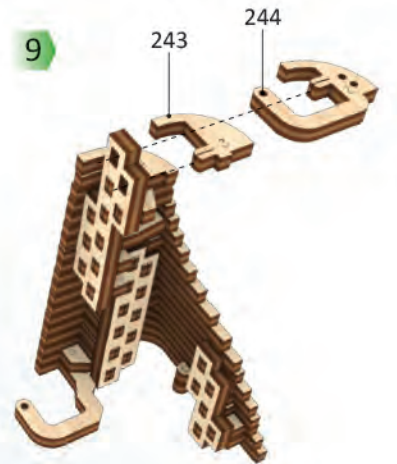

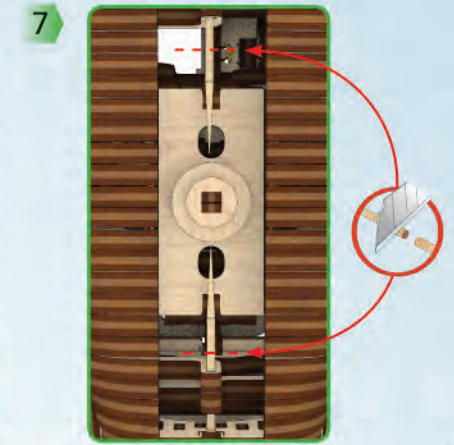
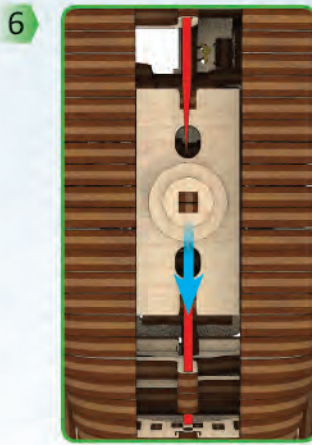
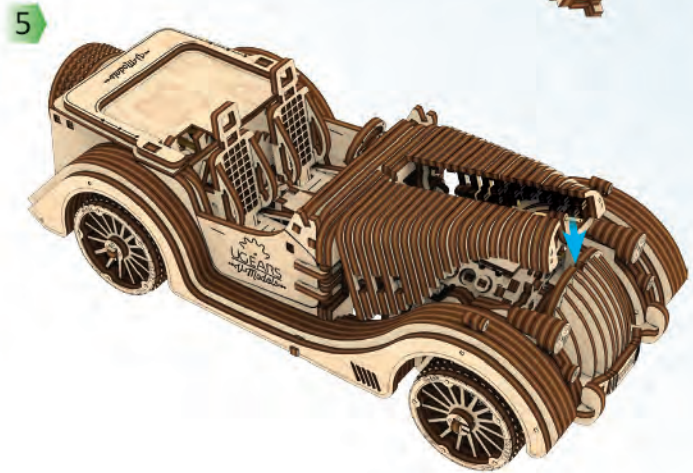
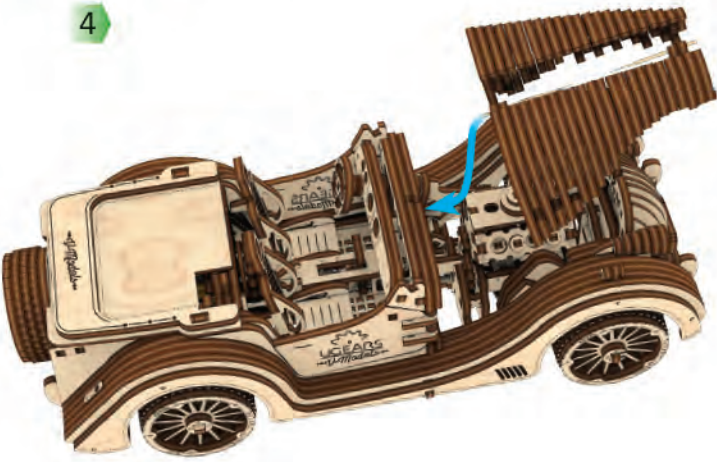
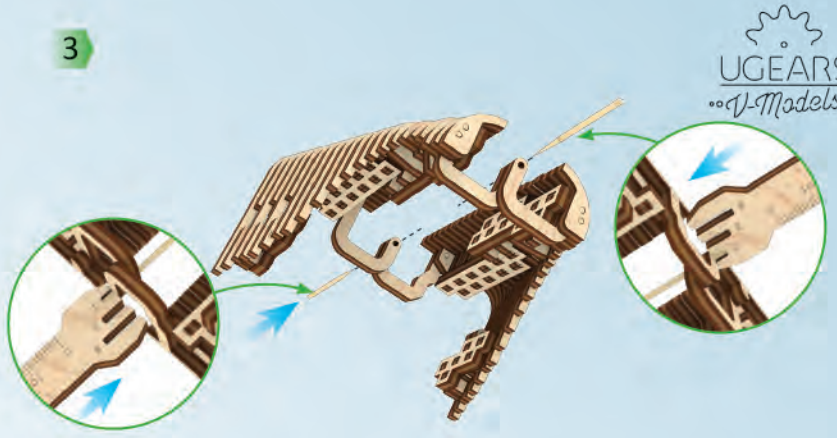
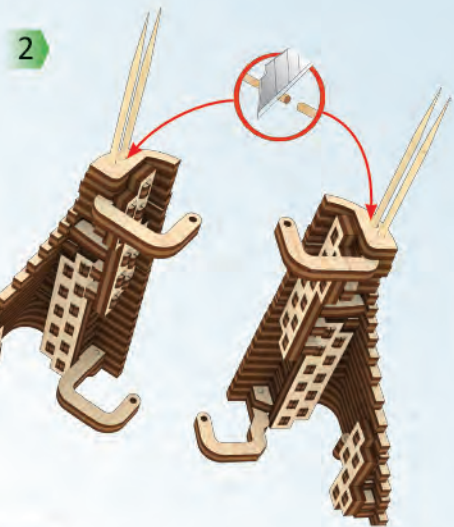
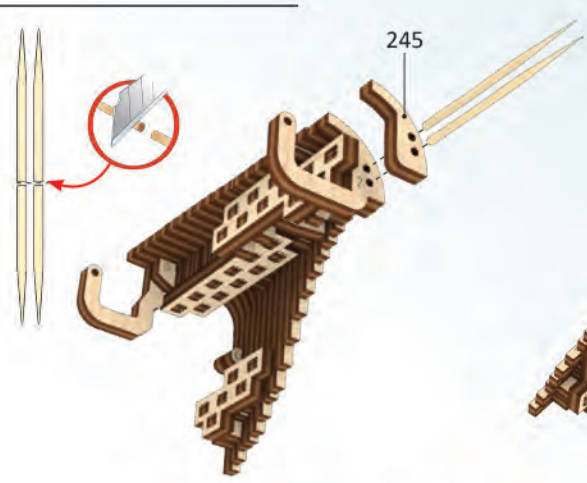

Mechanical models

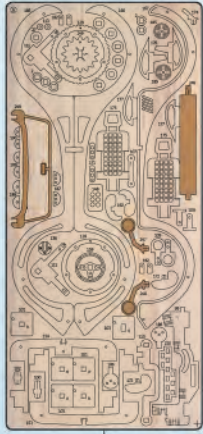

1

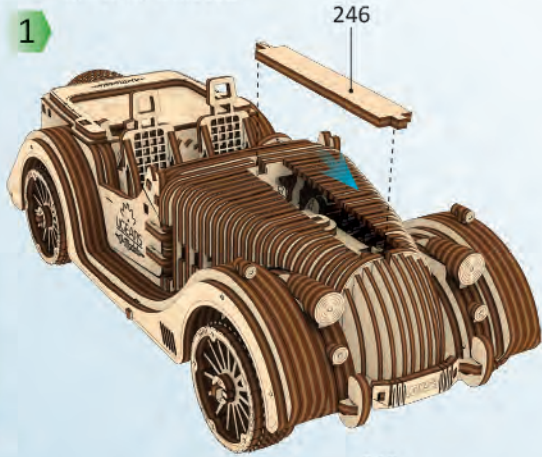

2

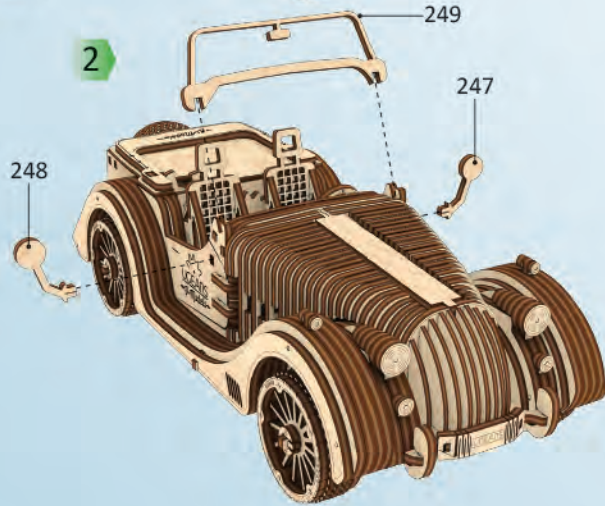

1

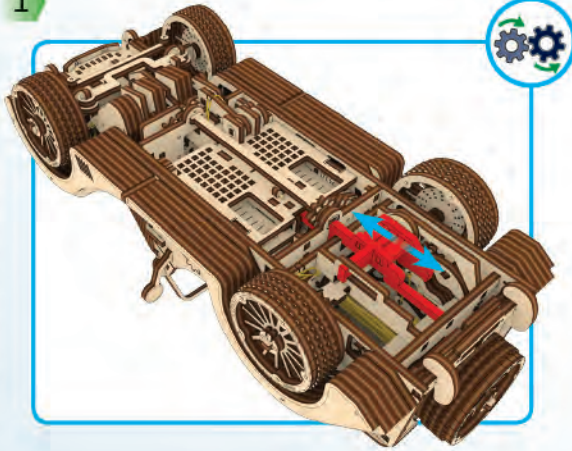

3

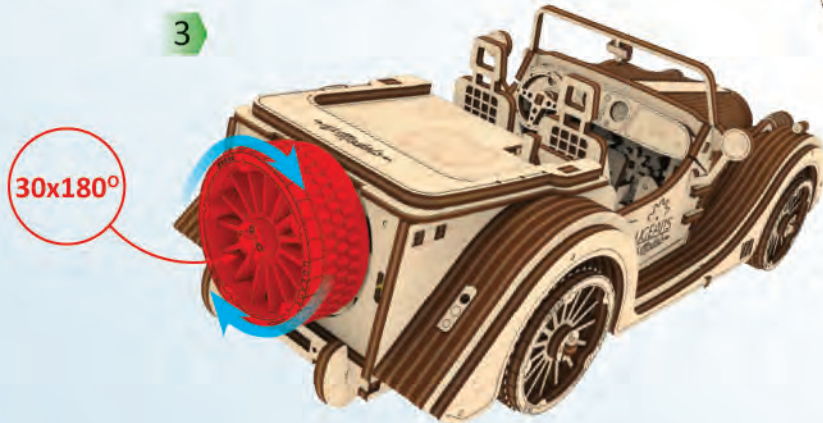

2

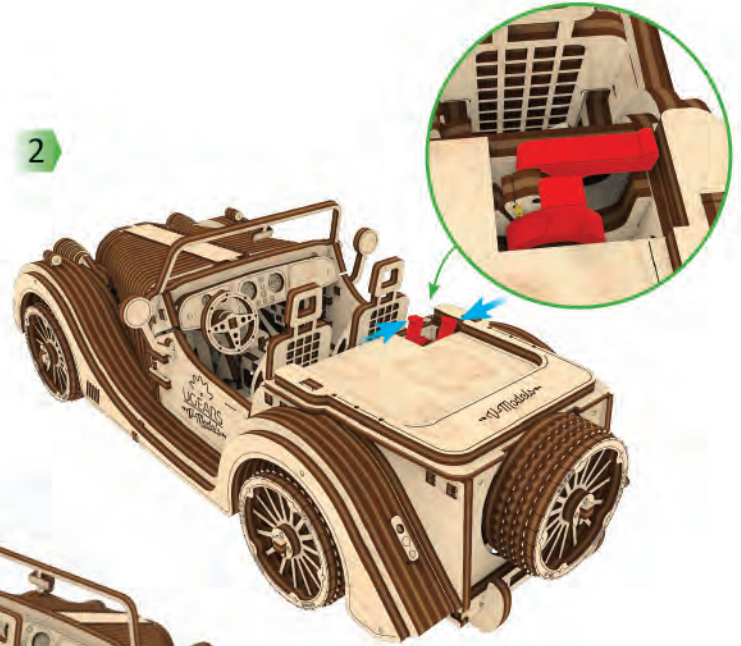

4

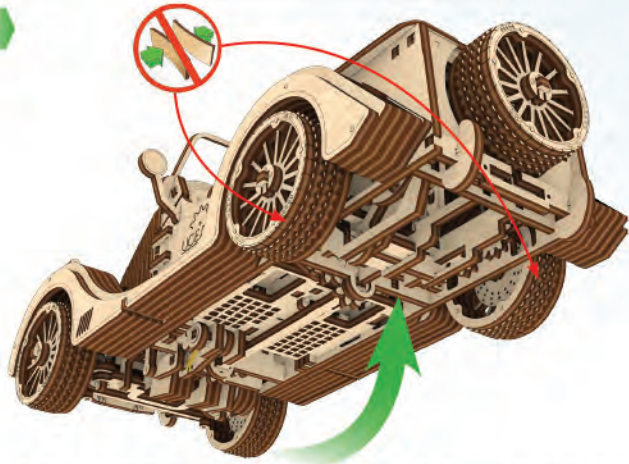

5

Drive forward



6

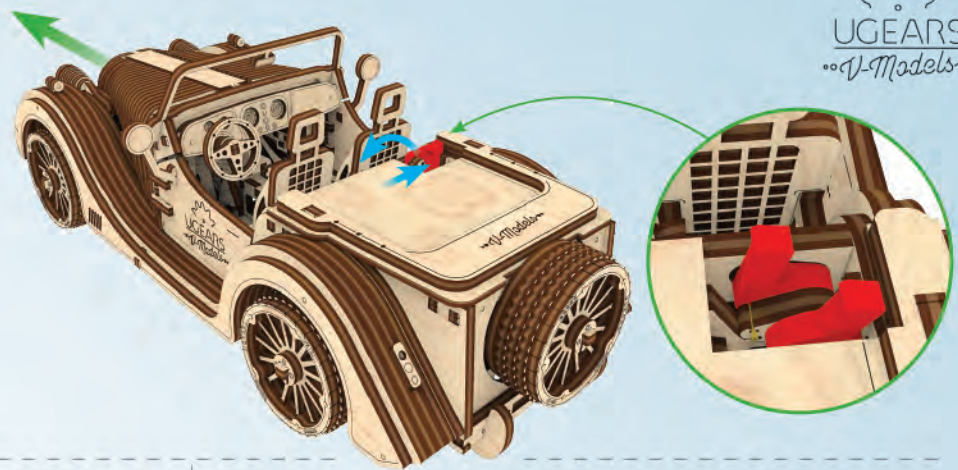

Neutral

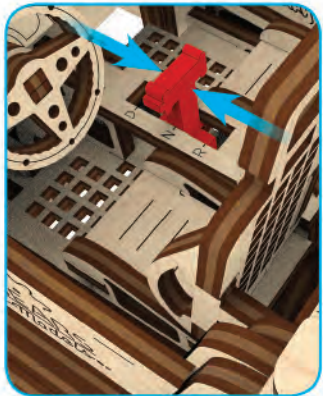

Reverse

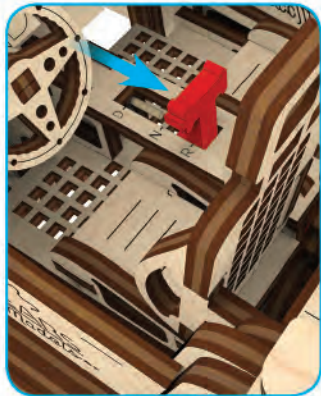

Slow mode

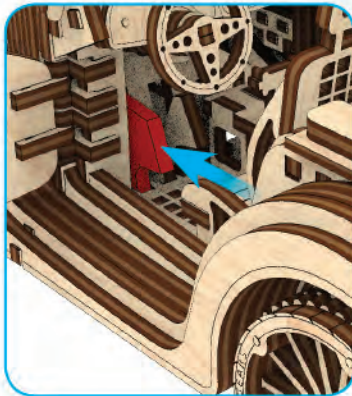

Fast mode

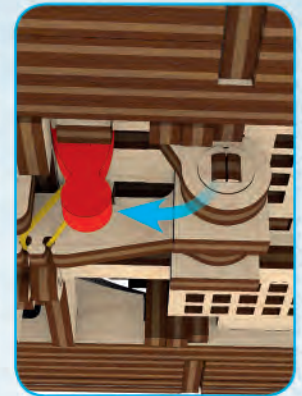
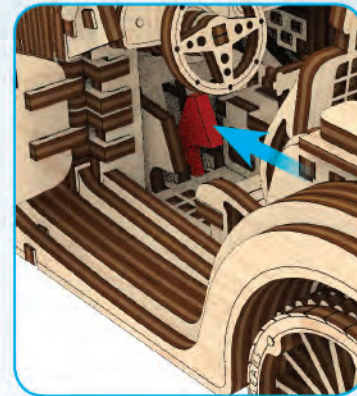

Assemble Me. Drive Me

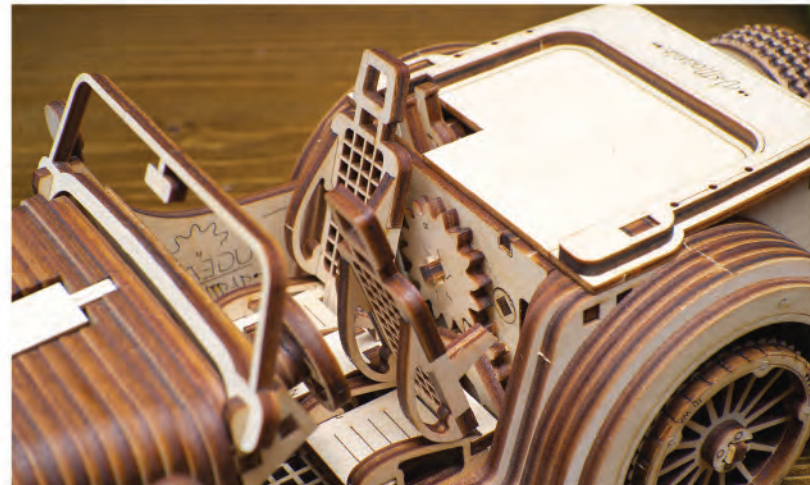
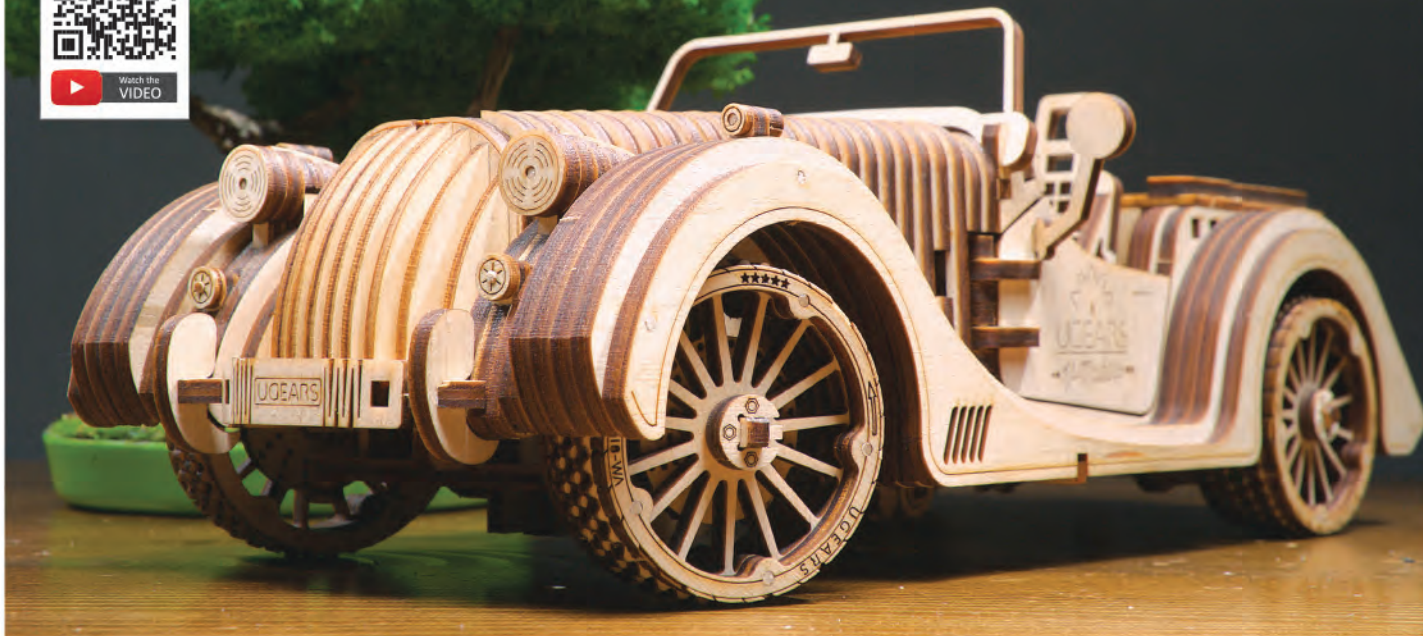

ENG Thanks for following along on this journey with us. UKR Дякуємо, що ви пройшли цей шлях з нами. DEU Vielen Dank, dass Sie diesen Weg mit uns gegangen sind. FRA Merci denous avoir accompagnés tout au long de ces étapes. POL Dziękujemy, że razem z nami pokonałeś tę drogę! SPA Gracias por haber recorrido el camino con nosotros. ITA Grazie per aver fatto uesto percorso con noi. RUS Спасибо, что вы прошли этот путь с нами. JAP UGEARSをご利用いただきありがとうございます。 KOR UGEARS 와 함께해 주셔서 감사합니다. CHI 感谢您参与有趣的模型装配过程。

ugearsmodels.com

ENG Customer support UKR Служба підтримки
DEU Kundendienst FRA Service client
POL Wsparcie klienta SPA Servicio al cliente
ITA Servizio di supporto RUS Служба поддержки
JAP お客様窓口 KOR 고객센터 CHI 客户支持

customerservice@ugearsmodels.com

