



Find out MORE

Assemble Me.
Whirl Me



NATURAL

Made from wood materials



NO GLUE CONNECTION

Assembling without glue and chemicals



SELF ASSEMBLY

Details are precisely cut and ready to assemble



MECHANICAL

The models produce motion



EDUCATIONAL

Helps the family promote thinking, problem-solving and learning

UGEARS®

Mechanical models

Model «Tower Windmill» Модель «Башта-Млин»

DEU Modell «Turm Windmühle». FRA Modèle «Moulin à Vent».
POL Model «Wieża - Młyn Wiatrowy». SPA Modelo «Molino».
ITA Modello «Mulino a Vento». RUS Модель «Мельница-Башня».
JAP 風車. KOR 풍차. CHI 塔式风车.

Assembly instructions Інструкція зі складання

DEU Aufbauanleitung. FRA Notice d'assemblage.
POL Instrukcja montażu. SPA Instrucciones de montaje.
ITA Istruzioni di montaggio. RUS Инструкция по сборке.
JAP 組み立て説明書. KOR 조립 설명서.
CHI 装配说明书.

ENG

Assembly instructions:
Remove model parts from the hanger board as illustrated below. Careful not to break parts. If a part does not remove easily, carefully cut it out with a knife. This model is intended for self-assembly without glue. If you have difficulty installing the axles, try waxing them with a regular candle. All moving parts can also be waxed during assembly to reduce friction when operating the model.

UKR

Інструкція зі складання:
Витягніть з дошки позначені на схемі деталі. Намагайтеся їх не зламати. Якщо деталь не виймається, надсічіть перемички ножом. Конструкція збирається без клею. У разі виникнення труднощів з протягуванням зубчистки (вісі) в отвір, потріть зубчистку об звичайну свічку. Також можна змастити свічкою всі деталі механізму, що рухаються, щоб зменшити тертя при обертанні.

DEU

Aufbauanleitung:
Bitte nie in der Zeichnung angegebenen Teile aus der Platte herausnehmen. Versuchen Sie bitte diese nicht zu brechen. Wenn sich ein Teil nicht herausnehmen lässt, schneiden Sie die Stege mit dem Messer leicht an. Das Modell wird ohne Klebstoffe zusammengebaut. Lässt sich eine Achse nur schwer in eine Öffnung einführen, reiben Sie diese mit einer Kerze etwas ein. Für besseres Gleiten schmieren Sie alle beweglichen Teile mit einer Kerze.

FRA

Notice d'assemblage:
Faites sortir de la planche les pièces comme indiquées sur le schéma. Tâchez de ne pas les casser. Si la pièce ne sort pas, incisez les collages/fixations avec un couteau. La construction est à assembler sans colle. Si il est difficile d'introduire l'axe en bois dans l'orifice, frottez au préalable l'axe ou les pièces contre une bougie. Pour améliorer le glissement, traitez les pièces de frottement mobiles du mécanisme avec une bougie au cours d'assemblage.

POL

Instrukcja montażu:
Delikatnie wyciągaj z deseczki wskazane w schemacie detale, starając się nie połamać elementów. Jeśli detal nie poddaje się, podetnij wiązadła nożem. Konstrukcje składa się bez kleju. Jeśli napotkasz trudności z instalacją drewnianej osi w otwór, potřzyj na początku oś lub detale o woskową świecę. Dla lepszego poślizgu polecano smarowanie ruchomych części mechanizmu zwykłą świecą podczas montażu.

SPA

Instrucciones de montaje:
Saque de la tabla las piezas marcadas en el esquema. Trate de no romperlas. Si una pieza no se saca, haga una incisión. La construcción va sin pegamento. Si tiene dificultades con la instalación del eje de madera en un agujero, frote primero el eje o las piezas contra una vela. Para un mejor deslizamiento, lubrique durante el montaje las piezas móviles del mecanismo con una vela común.

ITA

Istruzioni di montaggio:
Estrarre dal telaio i particolari indicati nello schema. Fare attenzione a non romperli. Se un particolare non si stacca, tagliare delicatamente gli elementi di collegamento con un coltello. L'assieme viene realizzato senza colla. In caso di difficoltà nell'inserimento di un perno in legno, È necessario sfregare il perno o il particolare con un po' di cera. Per uno scorrimento migliore incerare le parti mobili del meccanismo durante l'assemblaggio.

RUS

Инструкция по сборке:
Вынимайте из доски обозначенные на схеме детали. Старайтесь их не сломать. Если деталь не извлекается, надрежьте перемычки ножом. Конструкция собирается без клея. Если возникли трудности с установкой потрите детали об обычную свечу. Для лучшего скольжения смазывайте движущиеся детали механизма обычной свечой во время сборки.

JAP

組み立て説明書:
部品に傷をつけないように注意しながらボードから外してください。部品が外れにくい場合は連結部分をカッターで切ってから外すと外しやすいです。本製品は、接着剤がなくても組み立てができるように設計されています。もしアクスル(駆動部)が、歯車の動きがにぶい場合は、ロウソクをアクスルに塗ってください。全ての駆動部分は製品を動かす時、滑らかに動くように潤滑剤であるロウソクを塗りながら組み立てます。

KOR

조립 설명:
부품이 손상되지 않도록 주의하여 보드에서 떼어냅니다. 만약 부품이 잘 떨어지지 않으면 연결 부분을 칼로 절단 한 후 떼어내면 쉽게 떼어 낼 수 있습니다. 본 제품은 접착제가 없이 조립이 가능하도록 설계되어 있습니다. 만약 축이 잘 끼워지지 않는 경우 양초를 축에 바른 후 끼워 보세요. 모든 구동 부위는 제품 구동 시 원활한 작동이 가능하도록 조립 과정에서 윤활제(양초)양초를 발라 주세요.

CHI

装配说明:
将模型部件按插图示,从胶合板取下。小心不要损坏件。如果取下时候有难度,请用小刀小心的切割连接点。这个产品不需要胶水粘接。如果安装转轴的时候有难度,请用普通的蜡加以润滑。所有的转动部分也需要打蜡润滑。

ENG Warning! UKR Увага! DEU Achtung! FRA Attention! POL Uwaga! SPA Precaución! ITA Attenzione! RUS Внимание! JAP 注意! KOR 주의! CHI 注意!



ENG Do not use a lighted candle! **UKR** Не підпалювати! **DEU** Nicht anzünden! **FRA** Ne pas brûler! **POL** Nie podpalać! **SPA** ¡No encender! **ITA** Non dare fuoco! **RUS** Не поджигать! **JAP** 火のついたロウソクの使用はお止めください。 **KOR** 불이 붙은 초를 이용하지 마세요! **CHI** 请勿点燃, 请勿靠近火源!



ENG Caution! Axles have sharp points! **UKR** Обережно! Гострі деталі! **DEU** Vorsicht! Spitze Teile! **FRA** Attention: certaines pièces sont pointues! **POL** Ostrożnie! Ostre części! **SPA** ¡Atención! Piezas afiladas! **ITA** Attenzione! Particolari appuntiti! **RUS** Осторожно! Острые детали! **JAP** アクスル(駆動部)の鋭い部分にご注意ください。 **KOR** 축의 뾰족한 부분에 주의하세요! **注意! CHI** 舍尖锐部件!

ENG Customer support **UKR** Служба підтримки **DEU** Kundendienst **FRA** Service client **POL** Wsparcie klienta
SPA Servicio al cliente **ITA** Servizio di supporto **RUS** Служба поддержки **JAP** お客様窓口 **KOR** 고객지원 **CHI** 客户支持

ENG Symbols. UKR Умовні позначення. DEU Legende. FRA Légende. POL Oznaczenia umowne. SPA Leyenda. ITA Legenda. RUS Условные обозначения. JAP 記号. KOR 기호. CHI 图标含义.



ENG Wax the part with a regular candle (rub with a candle). UKR Змастіть деталь звичайною свічкою (потріть об свічку). DEU Reiben Sie das Teil mit einer einfachen Kerze etwas ein. FRA Lubrifiez la pièce avec une bougie ordinaire (frottez contre la bougie). POL Przesmaruj zwykłą świecą. SPA Engrase la pieza con una vela común (frote con una vela). ITA Incerare il componente (Sfregare con la cera). RUS Смажьте деталь обычной свечкой (потрите о свечку). JAP 表示された部分に潤滑剤としてロウソクを塗ってください。KOR 표시된 부분에 윤활을 위해 초를 칠해 주세요. CHI 用普通蜡烛涂抹润滑部件。



ENG Pay attention. Check for correct orientation or positioning. UKR Зверніть увагу. Перевірте розташування елемента. DEU Bitte Beachten. Prüfen Sie die Einbaulage des Elementes. FRA Faites attention. Vérifiez la disposition de l'élément. POL Zwróć uwagę. Sprawdź lokalizację elementu. SPA Atención. Compruebe la situación del elemento. ITA Prestare attenzione. Controllare la posizione del componente. RUS Обратите внимание. Проверьте расположение элемента. JAP 方向及び位置に注意して組み立ててください。KOR 방향 또는 위치에 주의해서 조립해 주세요. CHI 注意！检查部件方向和位置。



ENG Press the parts as far as they will go. UKR Притисніть деталі до упору. DEU Drücken Sie die Teile bis zum Anschlag. FRA Poussez les pièces à fond. POL Przyciśnij element, aż do oporu. SPA Pulse para detener las piezas. ITA Stingere bene i componenti. RUS Прижмите детали до упора. JAP 部品をできる限り押してください。KOR 부품을 양쪽에서 눌러서 고정해 주세요. CHI 用力紧密结合部件。



ENG The part should be easily rotated (moved). UKR Деталь повинна легко крутитися (рухатися). DEU Der Teil soll leicht gedreht (bewegt) werden. FRA La pièce doit tourner (se déplacer) aisément. POL Element powinien łatwo się kręcić (poruszać się). SPA La pieza debe ser fácil de girar (mover). ITA Il componente deve girare (muoversi) facilmente. RUS Деталь должна легко крутиться (двигаться). JAP 部品はしっかりと動かなければなりません。KOR 활하게 움직일 수 있어야 합니다. CHI 此部件必须容易的旋转 (移动)。



ENG Check the mechanism for smooth and correct movement. Operate the mechanism to seat the parts in their positions. UKR Перевірте механізм на плавність і точність ходу. Розробіть механізм. DEU Prüfen sie den Mechanismus bezüglich der Laufruhe und der Genauigkeit des Ganges. Arbeiten Sie den Mechanismus aus. FRA Vérifiez si le mécanisme fonctionne en douceur et avec précision. Faites fonctionner le mécanisme jusqu'à son fonctionnement normal. POL Sprawdź płynność i dokładność ruchu mechanizmu. Dopracuj mechanizm. SPA Verifique la suavidad y precisión del mecanismo. Desarrolle el mecanismo. ITA Controllare la scorrevolezza e la precisione del movimento. Far funzionare il meccanismo. RUS Проверьте механизм на плавность и точность хода. Разработайте механизм. JAP 駆動部分が滑らかに動くかを確認しながら作業をすすめます。KOR 구동 부분의 원활한 작동과 정확한 움직임을 확인하세요. CHI 检查机构的运行平稳度和精确度。调试机构。



ENG Sand to remove burrs. UKR Видаліть задирки. DEU Grate entfernen. FRA Eliminez les bavures. POL Usuń zadziory. SPA Quite las rebabas. ITA Togliere le bave. RUS Удалите заусенцы. JAP バリ取りのサンドペーパー。KOR 거친 부분을 다듬어 주세요. CHI 磨掉毛刺。



ENG Break off or cut out. UKR Відламайте або відріжте. DEU Abbrechen oder Abschneiden. FRA Coupez ou cassez. POL Odłam lub odetnij. SPA Rompa o corte. ITA Staccare o tagliare. RUS Отломайте или отрежьте. JAP 切ってください。KOR 잘라내 주세요. CHI 切断。



ENG Spare parts. UKR Запасні деталі. DEU Ersatzteile. FRA Pièces de rechange. POL Części zamienne. SPA Piezas de repuesto. ITA Pezzi di ricambio. RUS Запасные детали. JAP 予備部品. KOR 여유 부품입니다. CHI 备用件。

ENG This is not a structural component; it is a tool for measurement and assembly. UKR Це не деталь конструкції, а допоміжний інструмент для складання або вимірювання відстаней. DEU Es ist kein Teil der Konstruktion, sondern ein Hilfselement für den Zusammenbau oder für das Messen der Abstände. FRA Cette pièce ne fait pas partie de la construction mais constitue un outil annexe pour l'assemblage ou la mesure des distances. POL To nie detal konstrukcji, a pomocnicze narzędzie dla montażu i wymiaru odległości. SPA No es una pieza de la construcción sino un instrumento auxiliar para montar o para medir distancias. ITA Non è un componente del modello, ma un'attrezzatura aggiuntiva per il montaggio o il rilievo delle quote. RUS Это не деталь конструкции, а вспомогательный инструмент для сборки или измерения расстояний. JAP この部品は完成時の部品ではなく、組み立てをサポートしたり測定する道具です。KOR 이 부품은 조립을 위한 부품이 아니고 조립을 돕거나 측정을 위한 도구입니다. CHI 这不是装配零部件，是一种测量及安装辅助工具。



Mechanical models

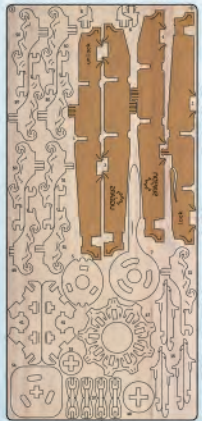

①

1

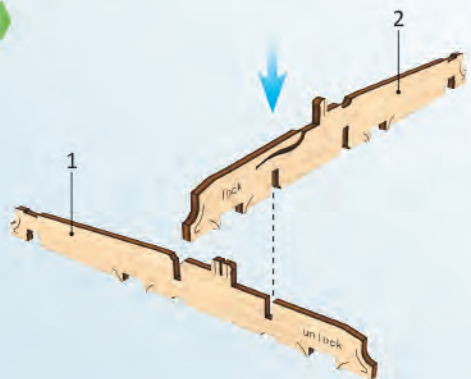

2

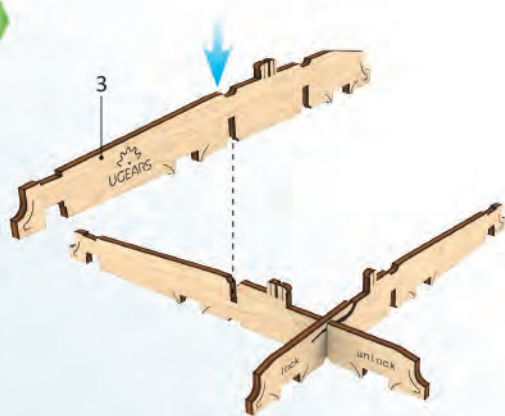

3

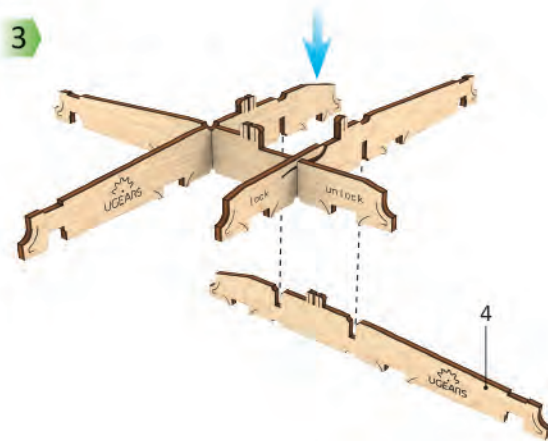

4



5

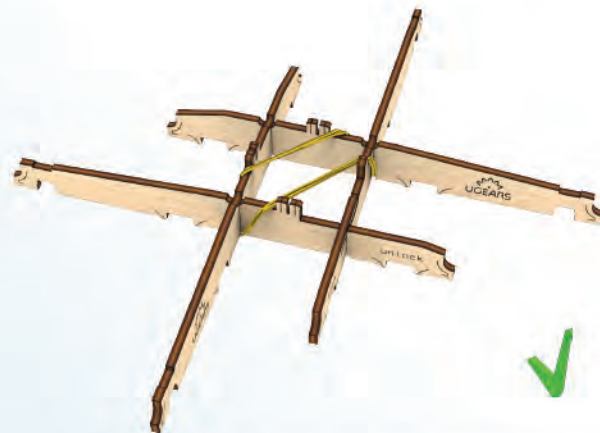
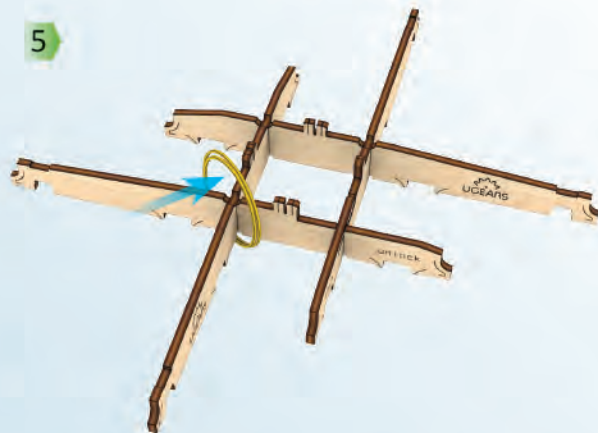

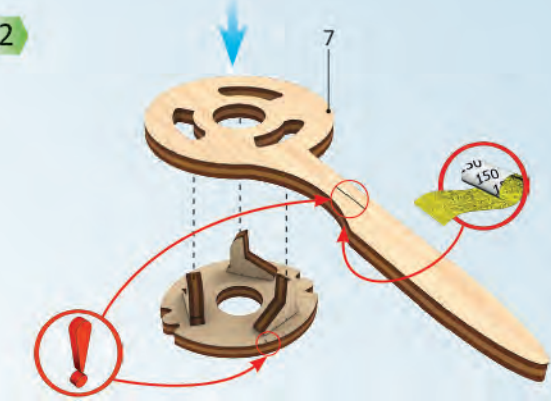
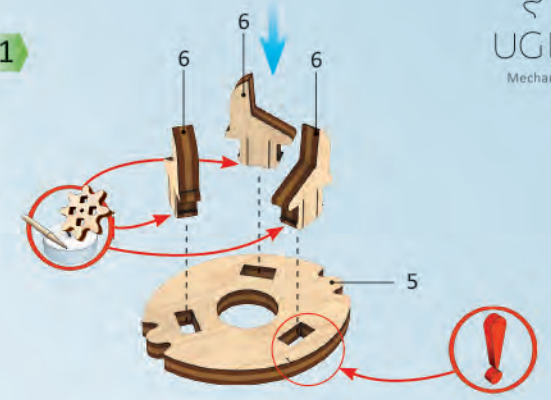
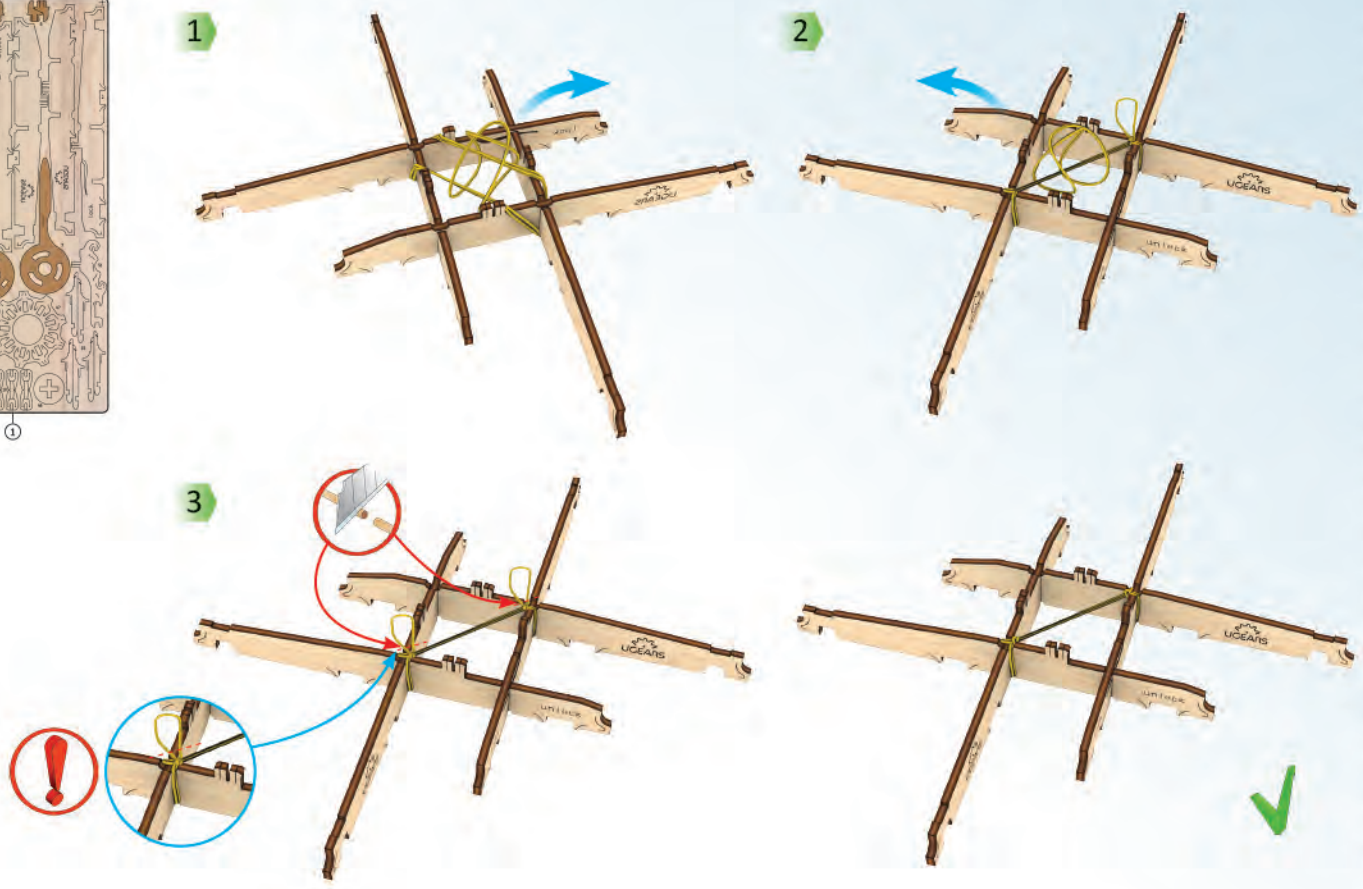
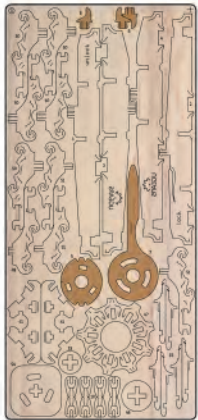

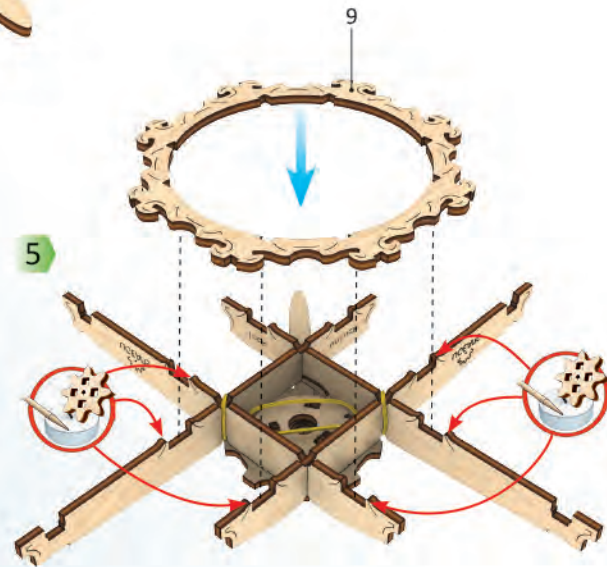
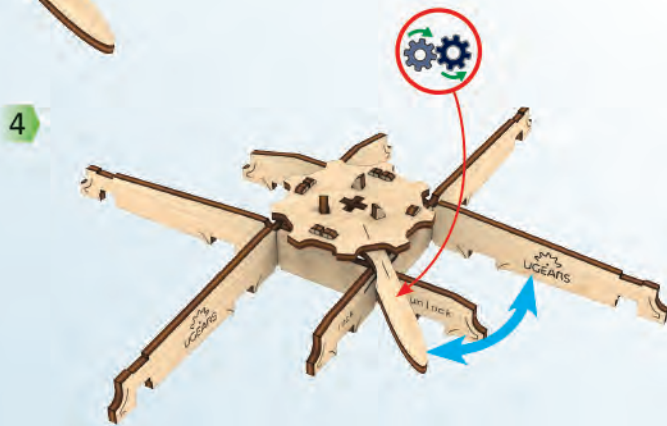
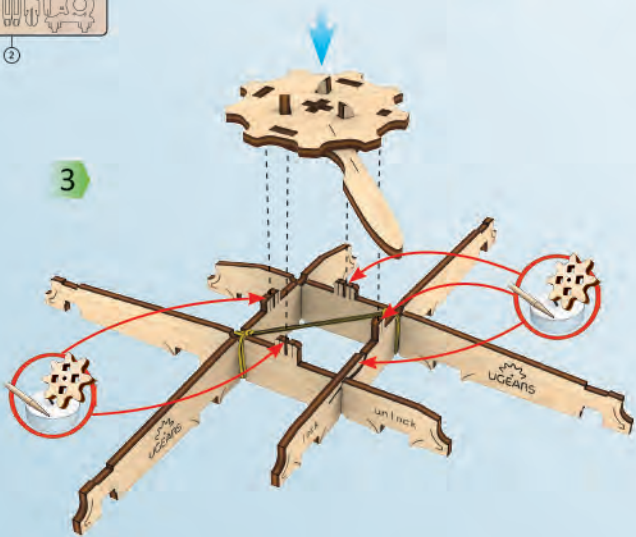
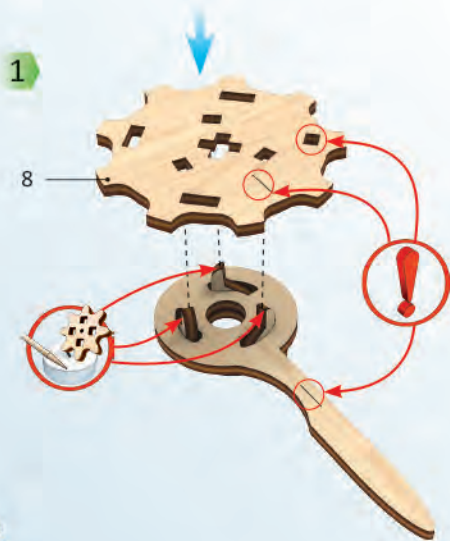
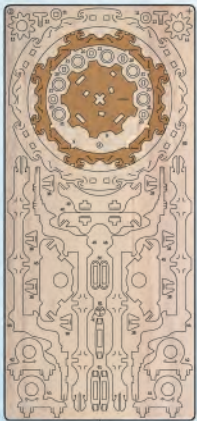

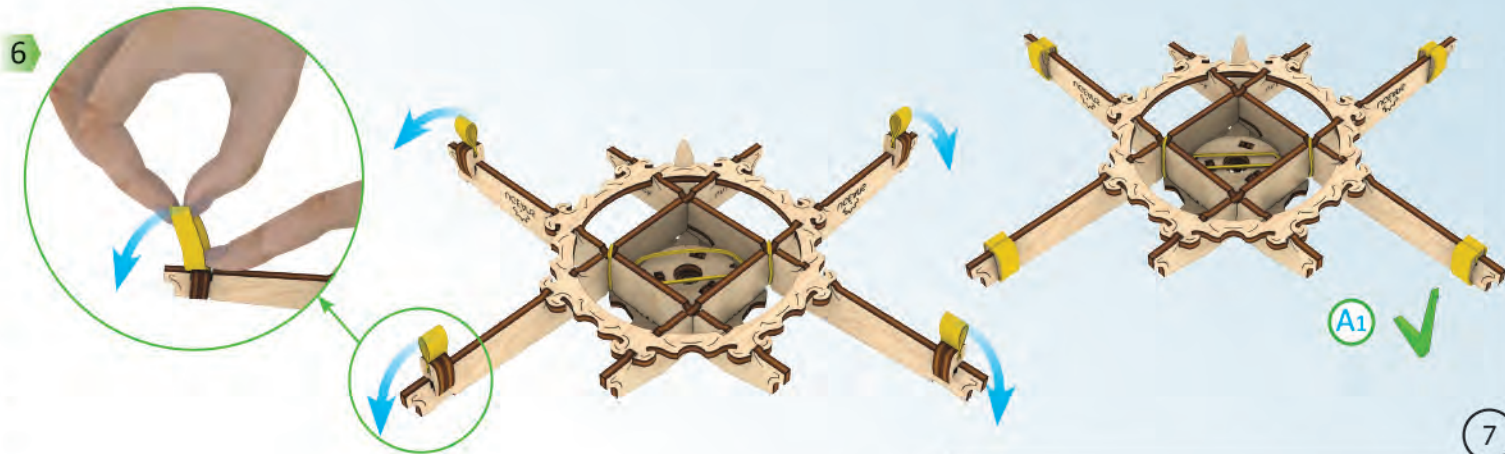
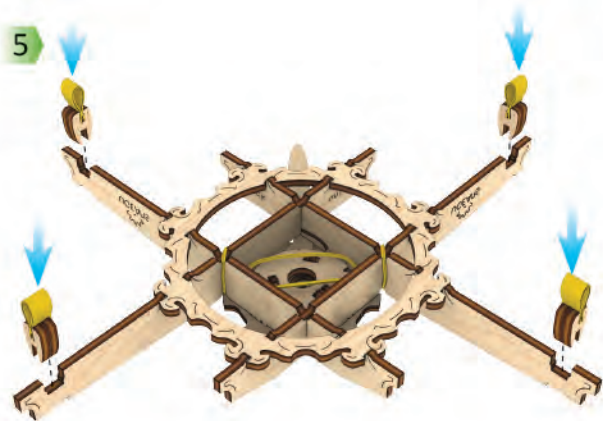
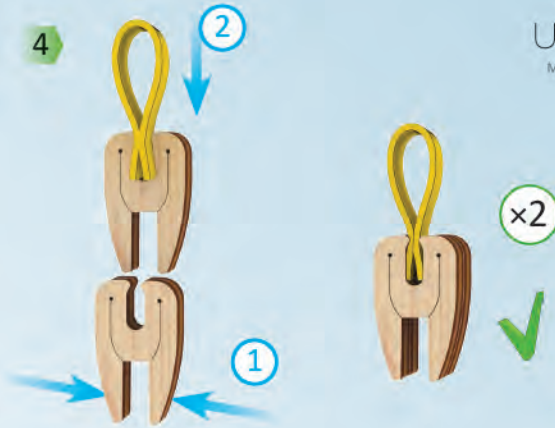
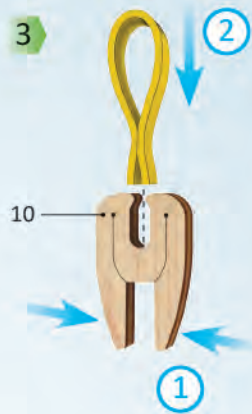
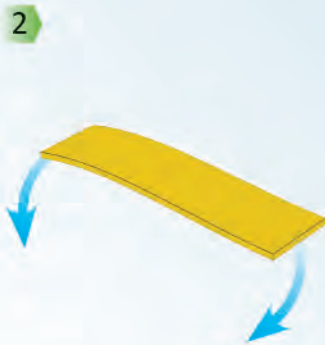
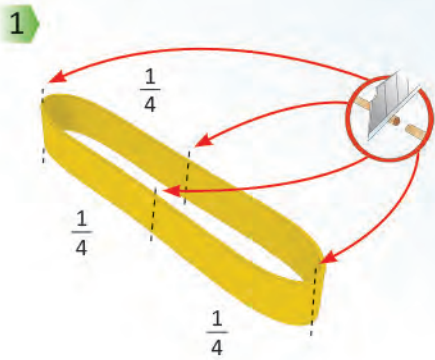
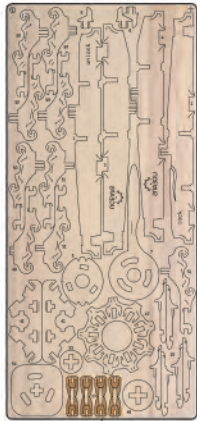



25

26

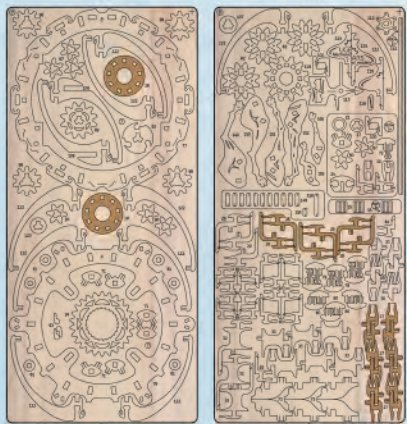

27

28

1

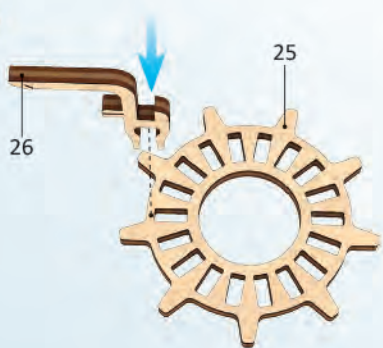

2



3



4

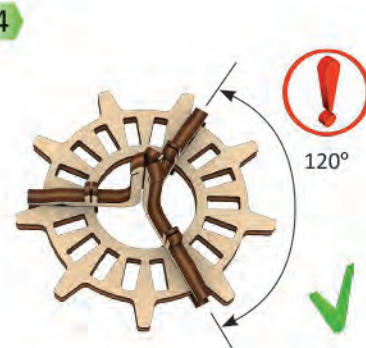

5



6



7

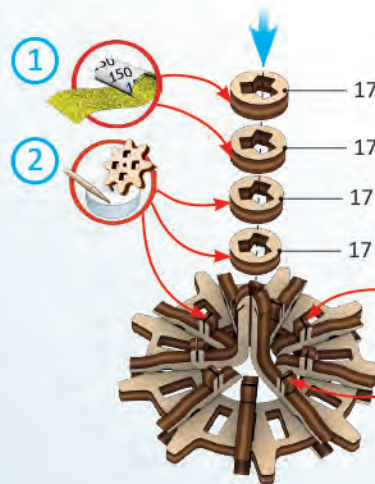

8

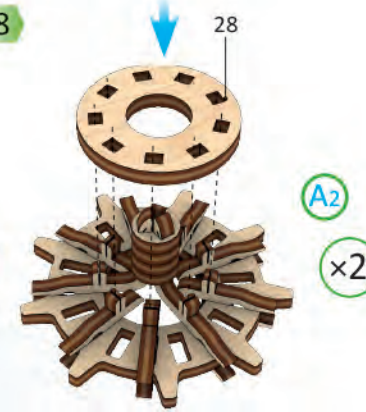

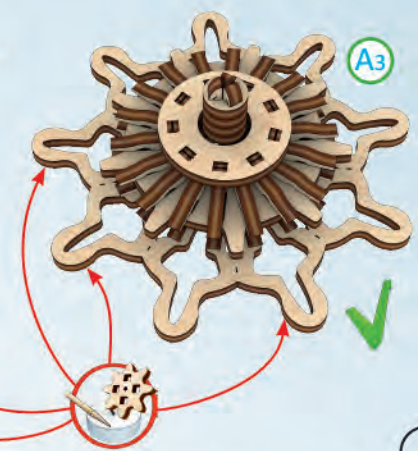
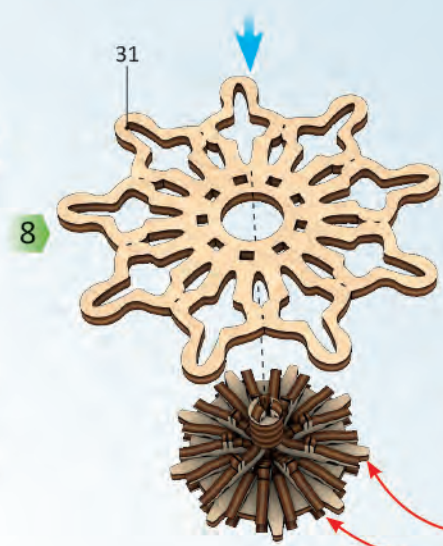
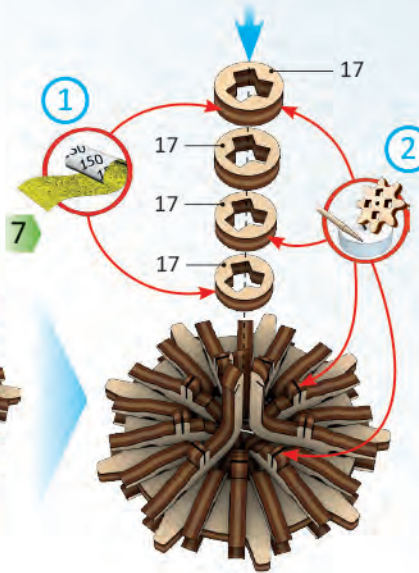
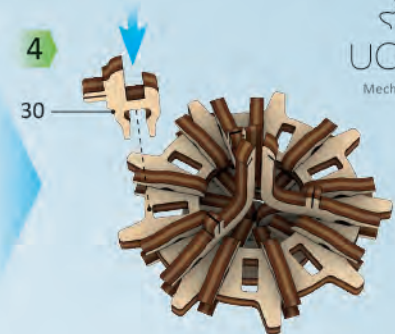
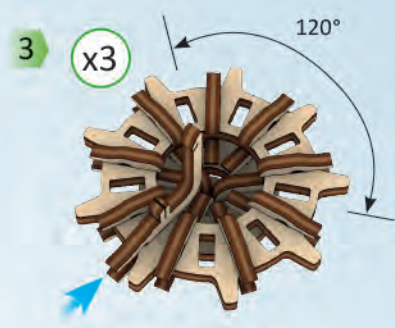
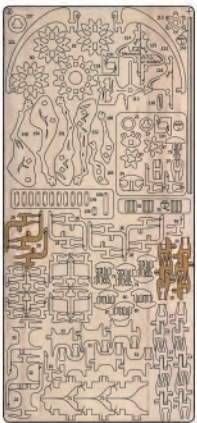
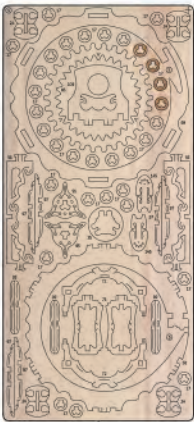
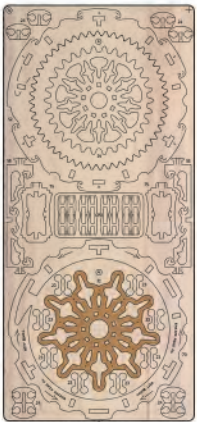

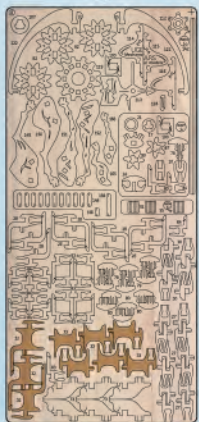

1



2



3

x6



4

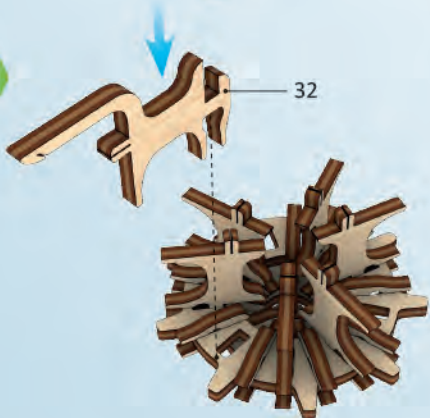

5



6

x3



7

1



2





1

2

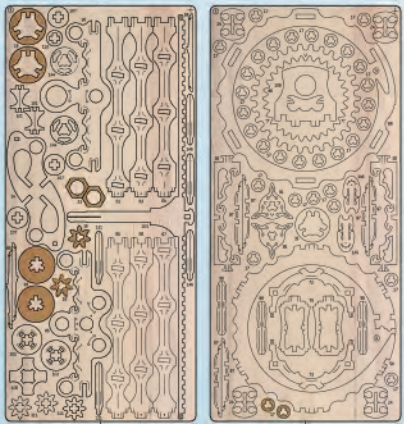

3

4

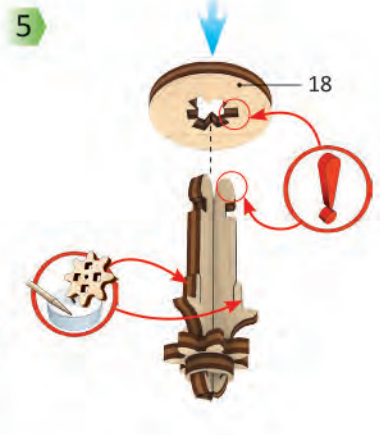
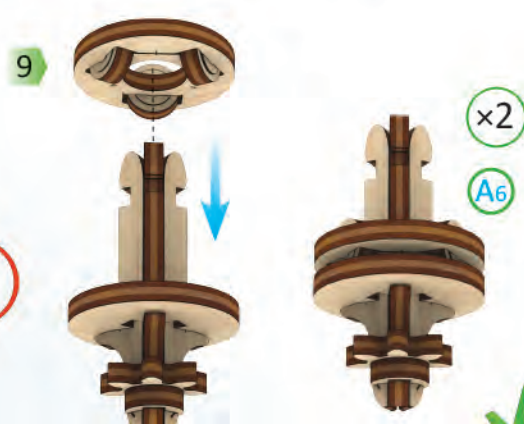
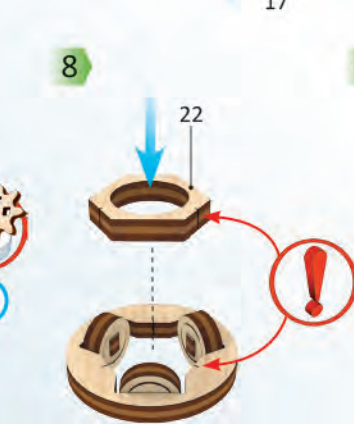
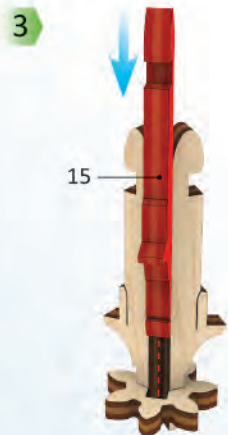
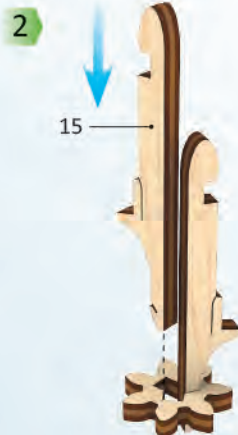
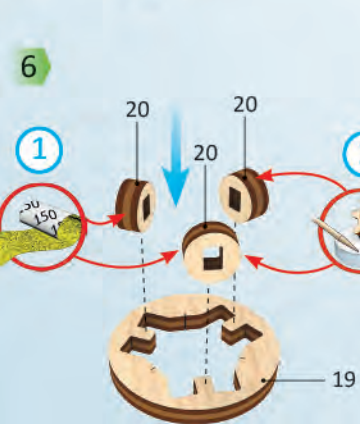

x2

A6

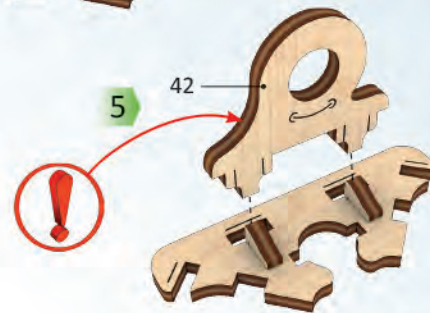
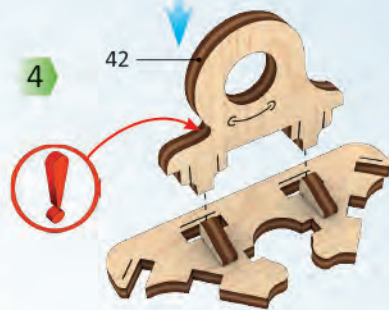
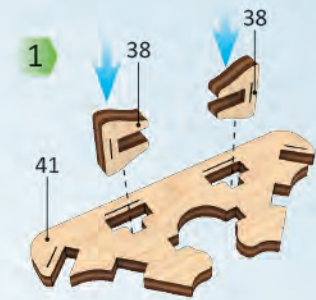
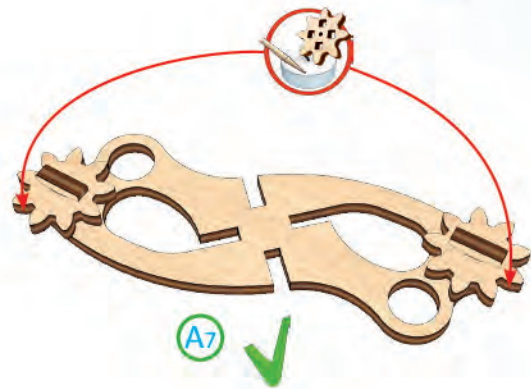
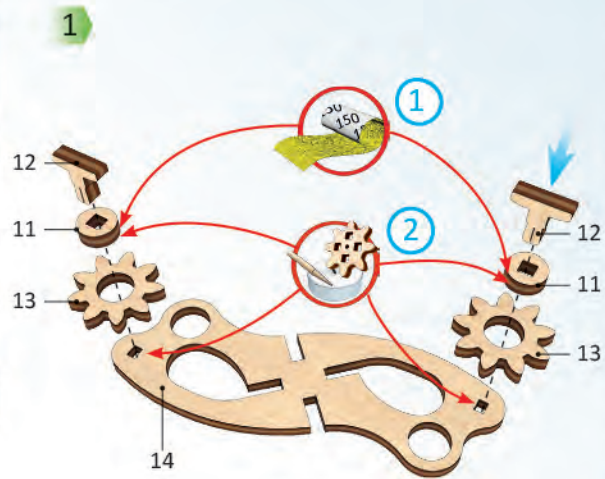
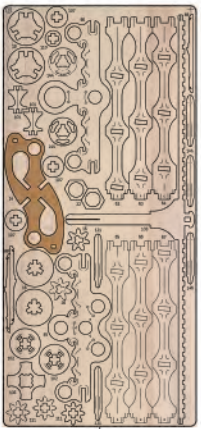
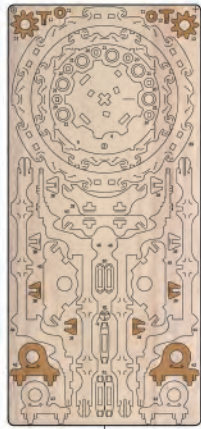
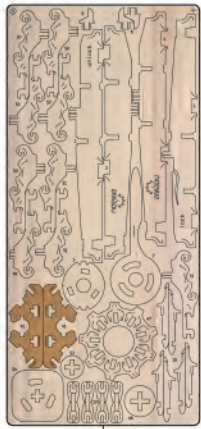

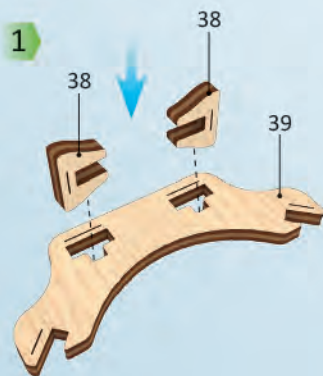
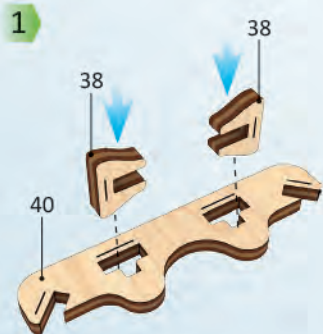
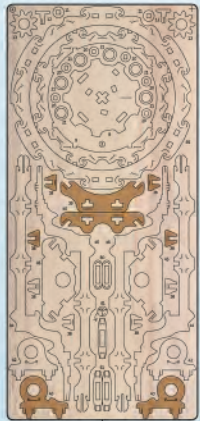

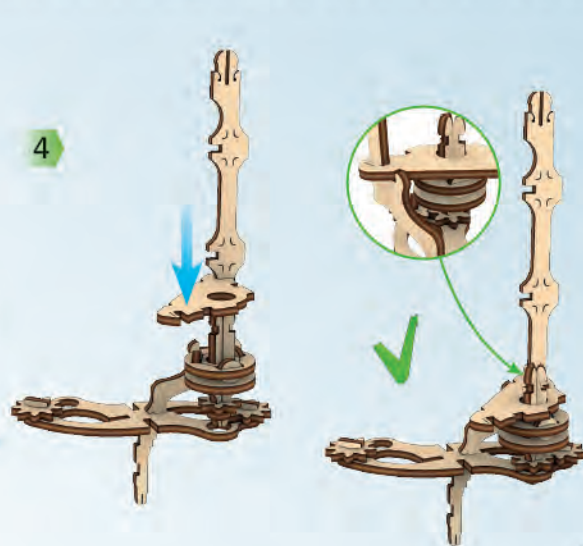
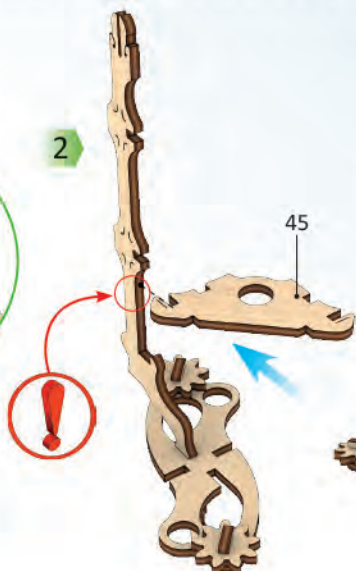
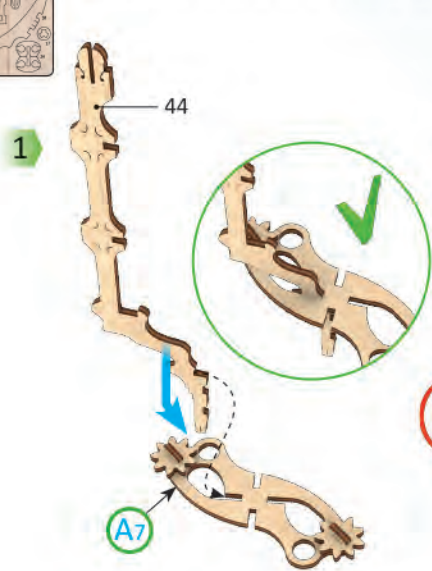
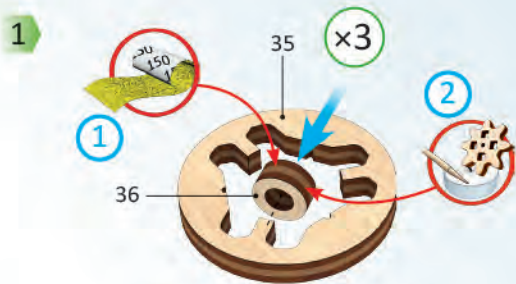
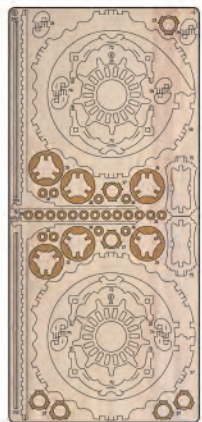
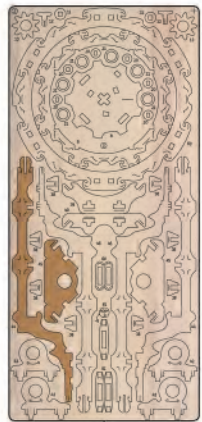

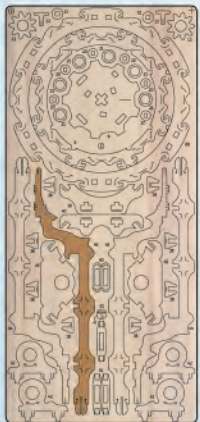

⊖

1

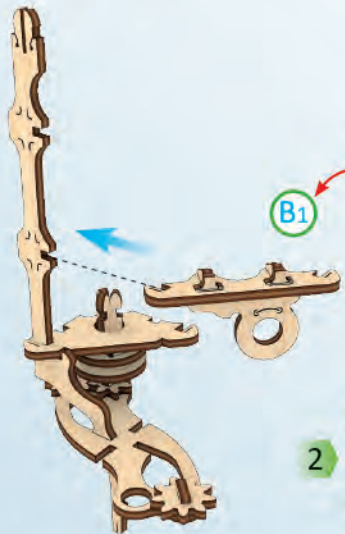

B1



2



A8

3

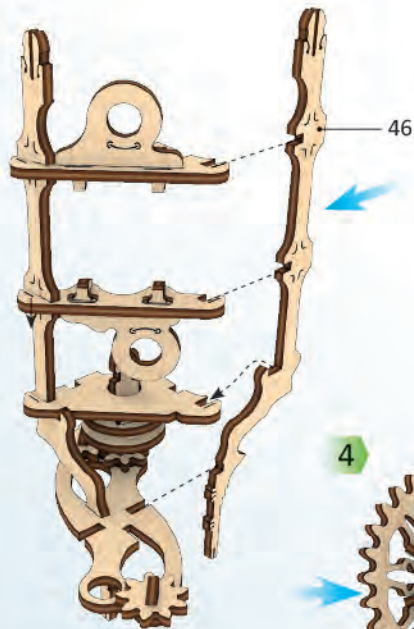

46

4

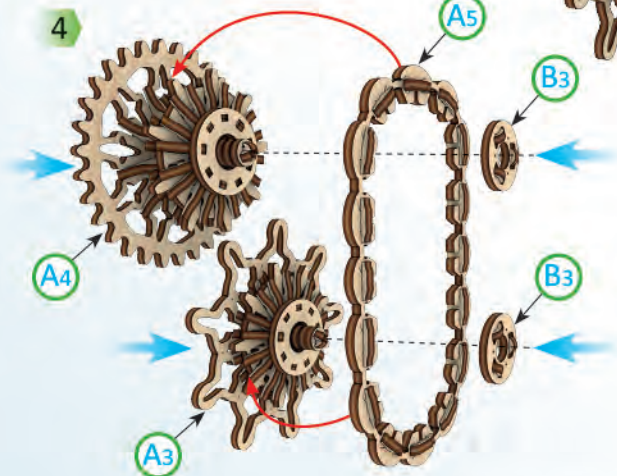

A4

A3

A5

B3

B3

5

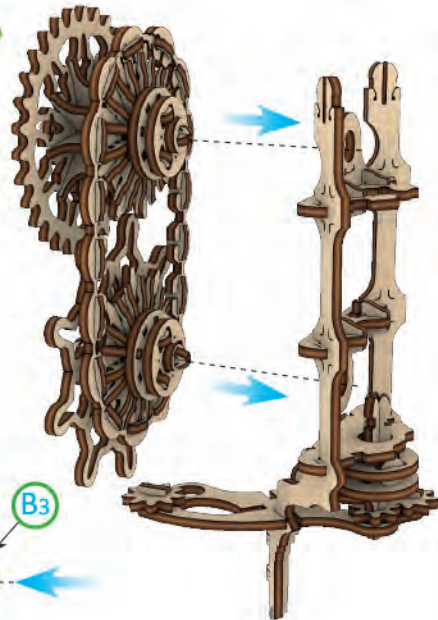

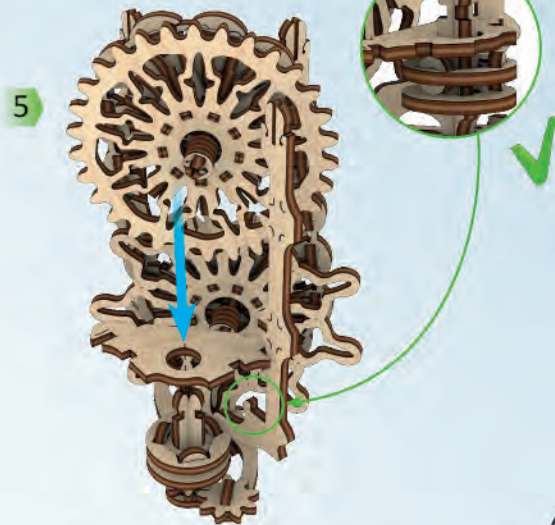
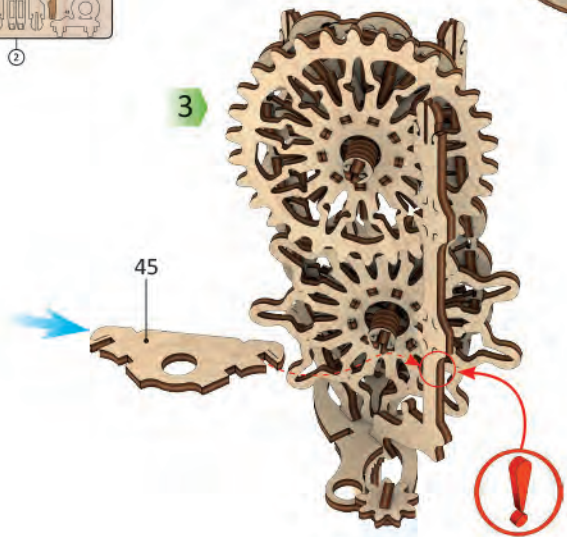
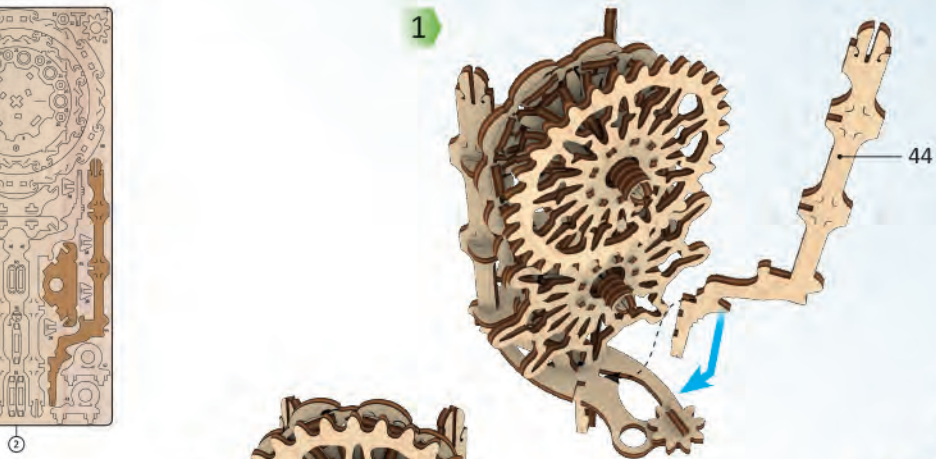
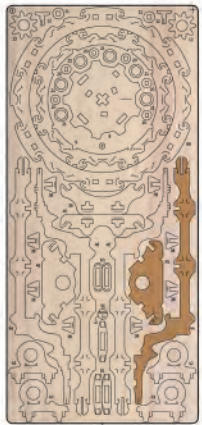

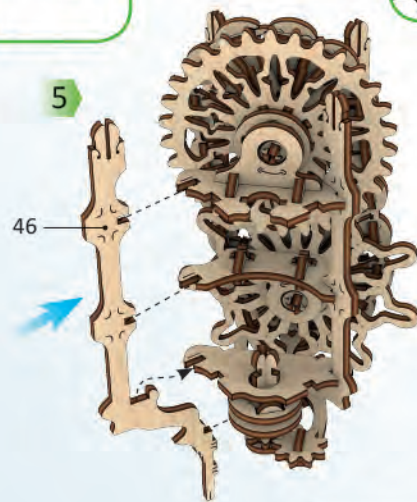
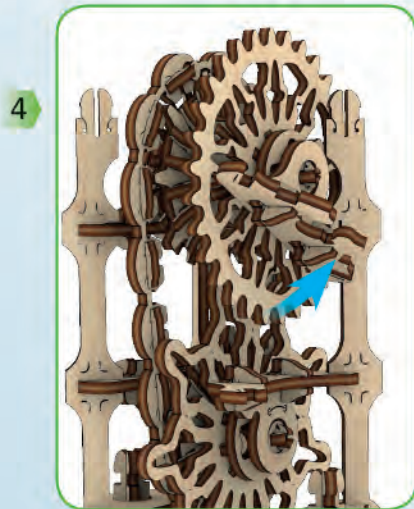
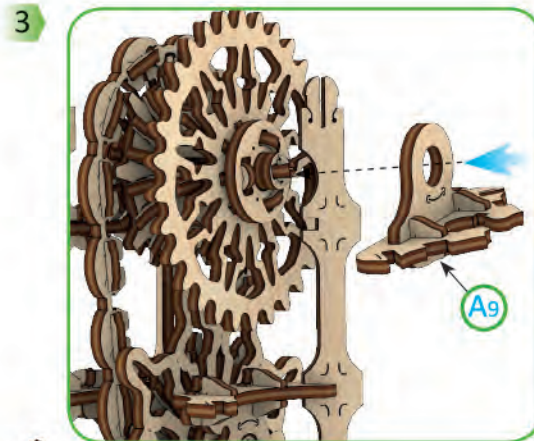
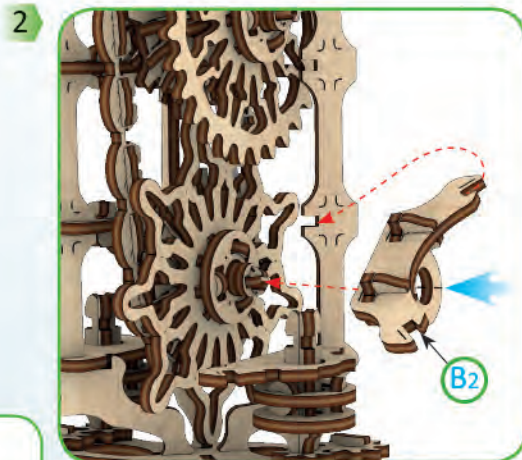
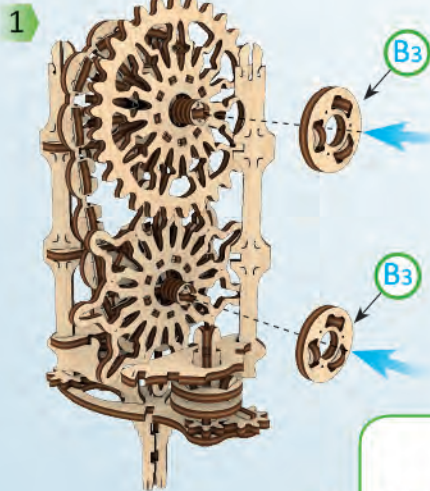
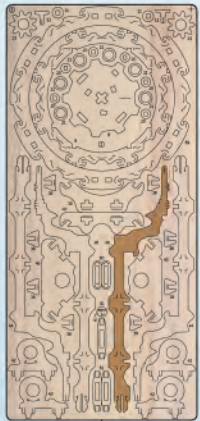

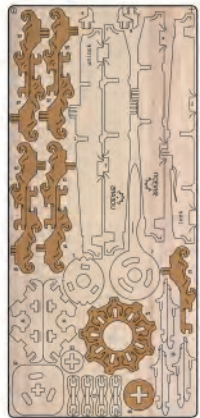

1

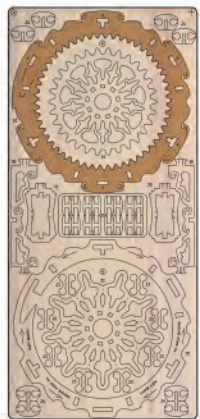

2

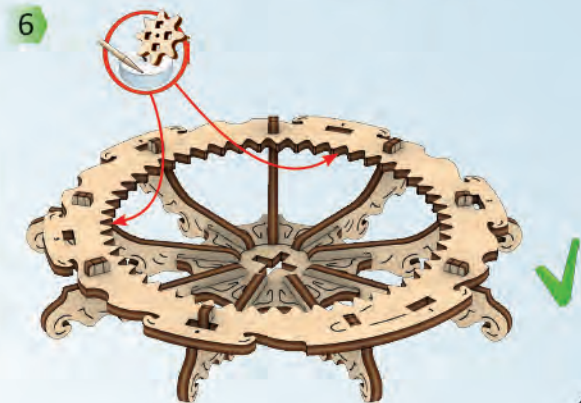
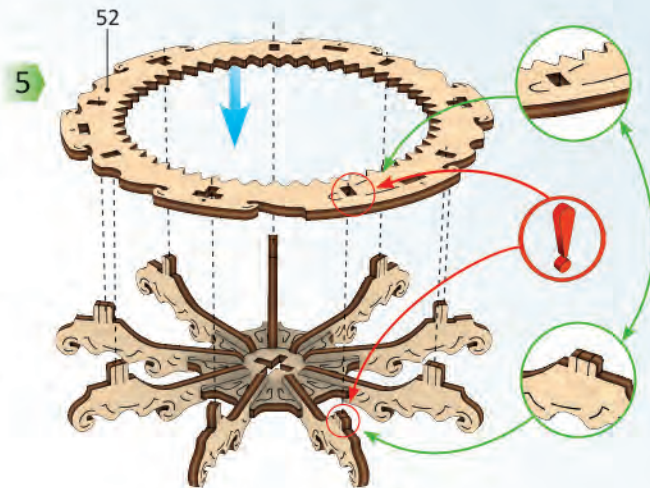
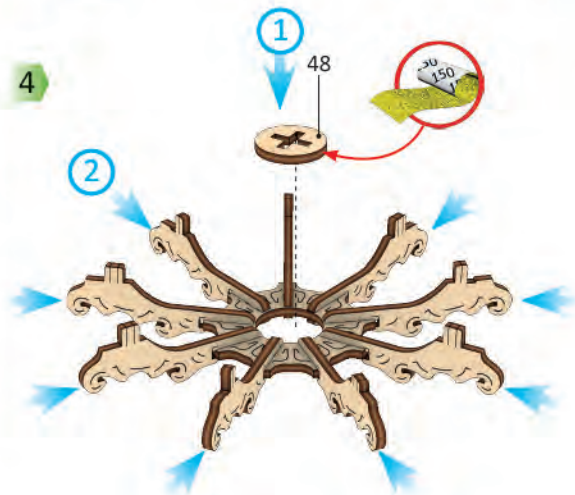
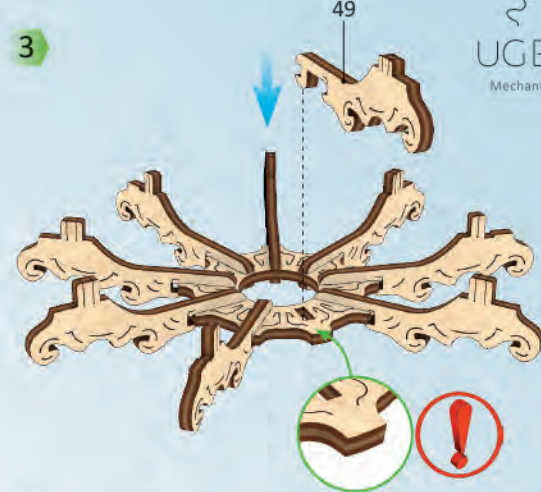
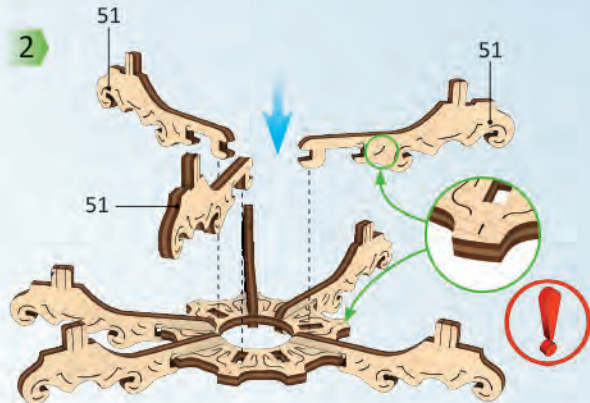
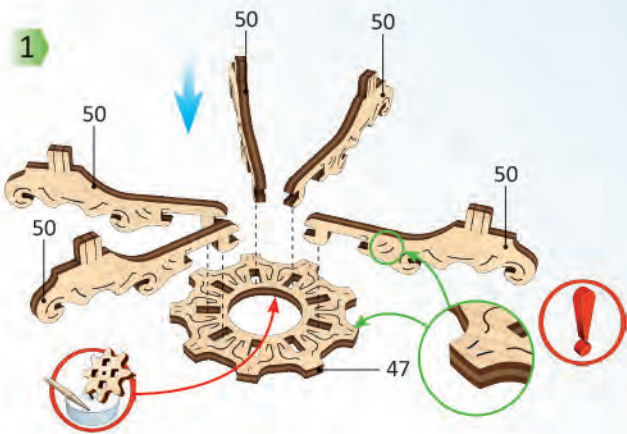

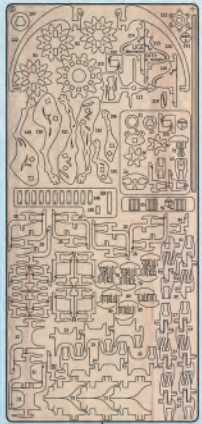
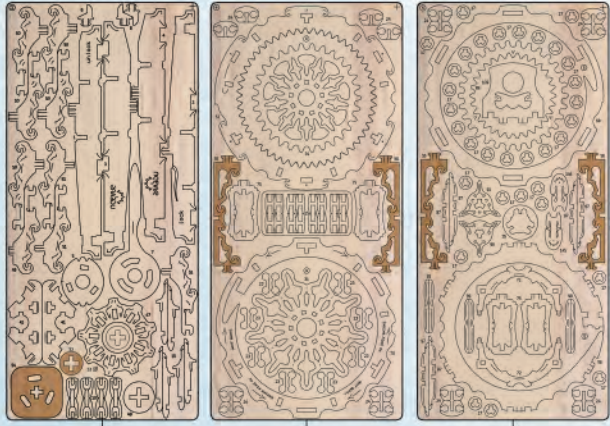

4

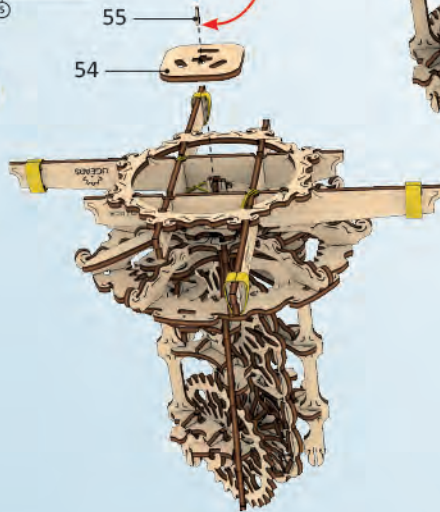

1

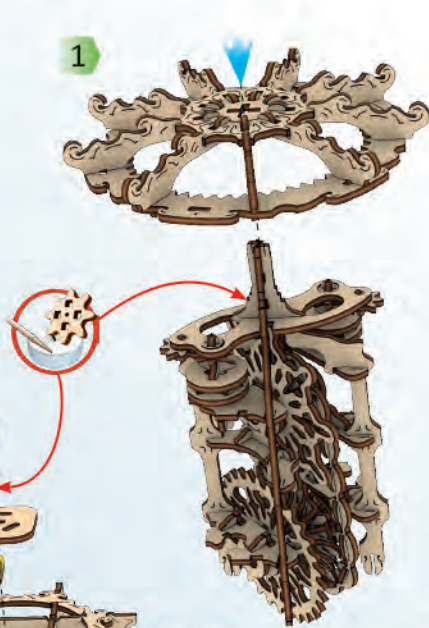

2

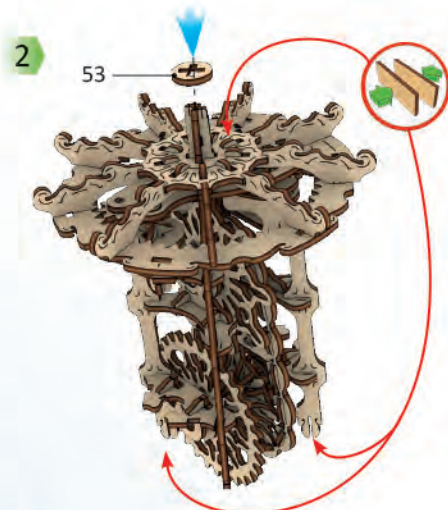

3

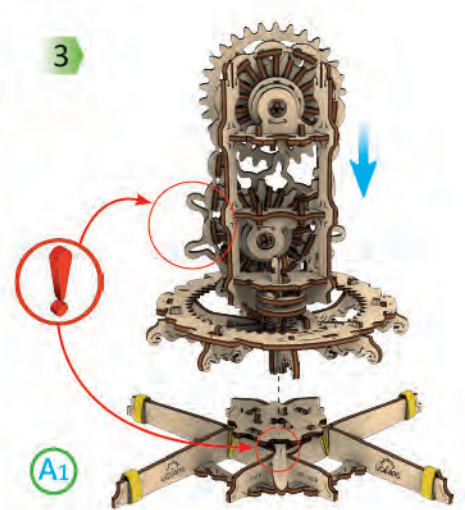

A1

5

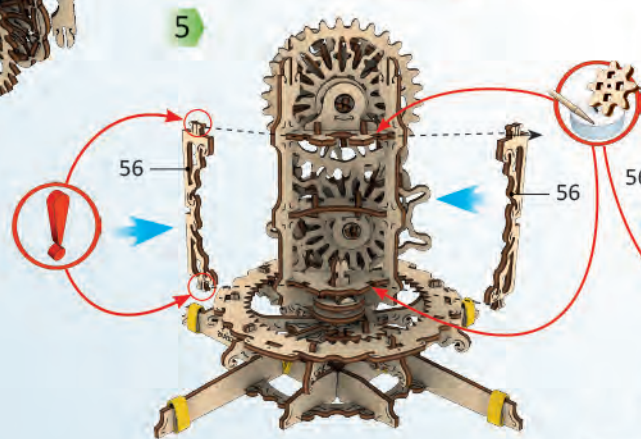

6

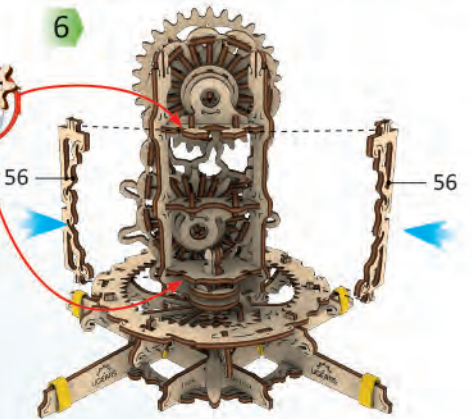

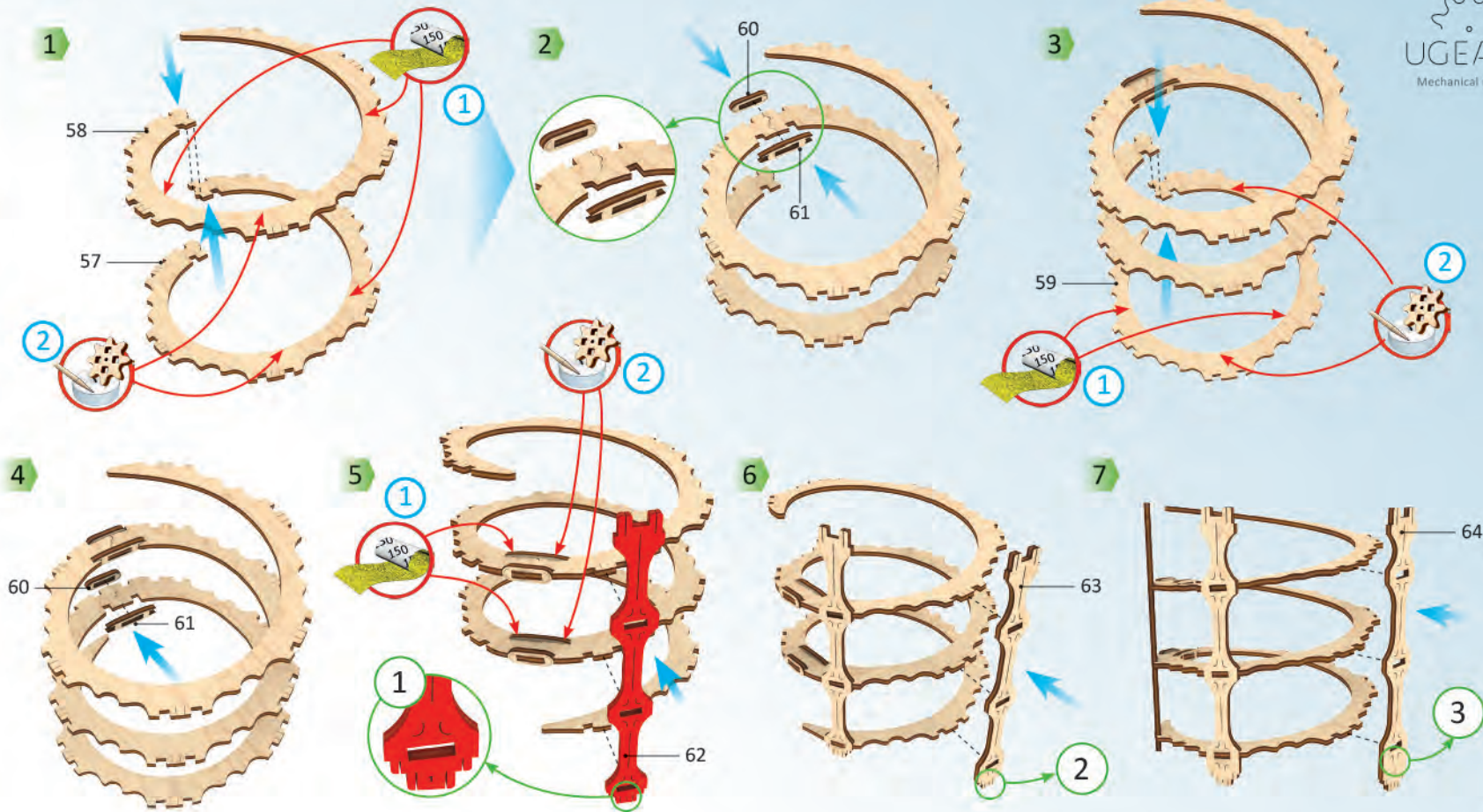

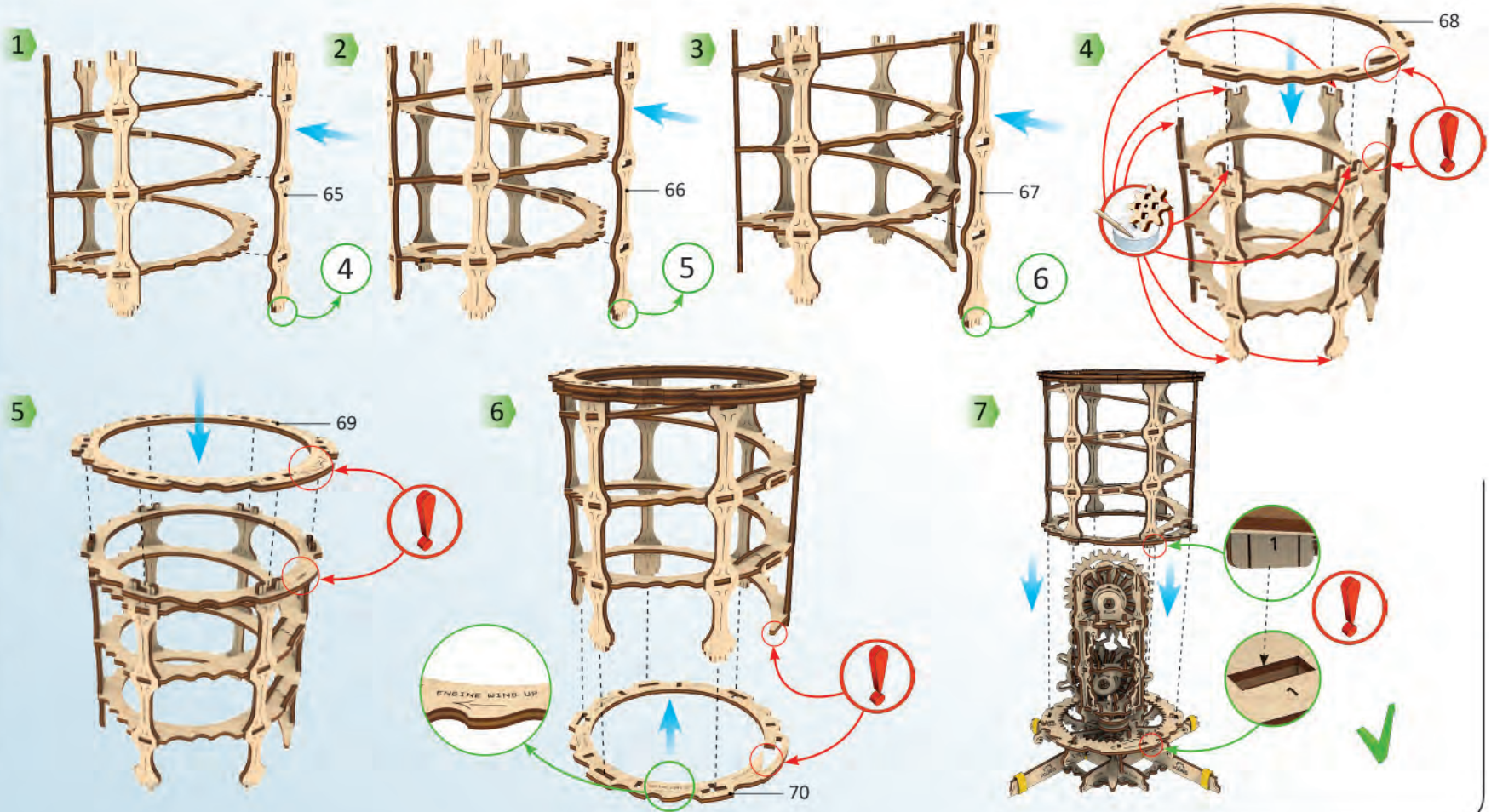
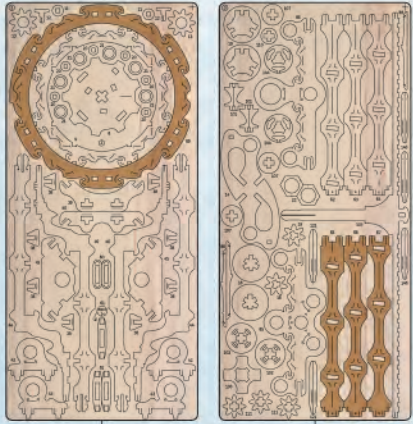

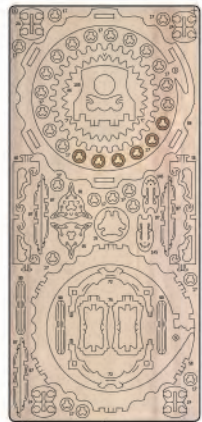

9



8

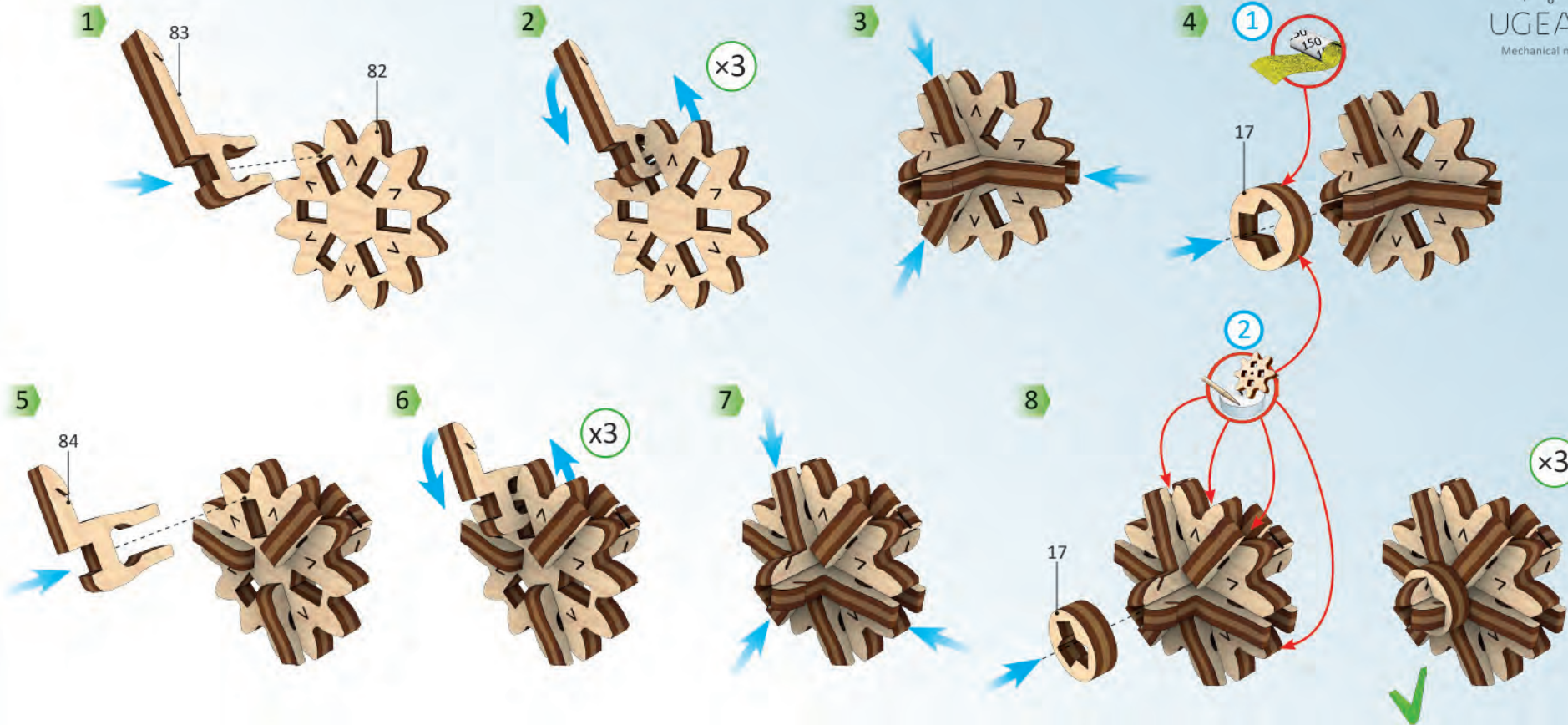

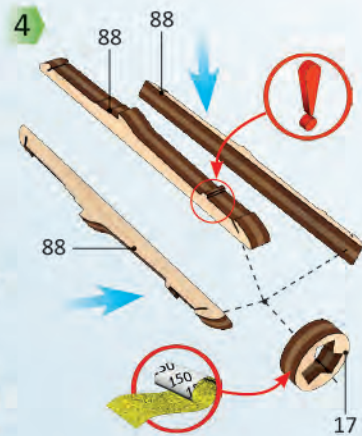
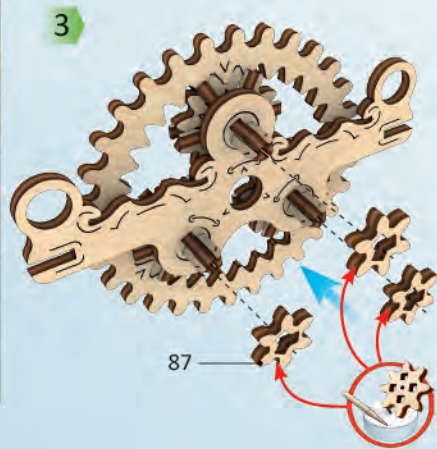
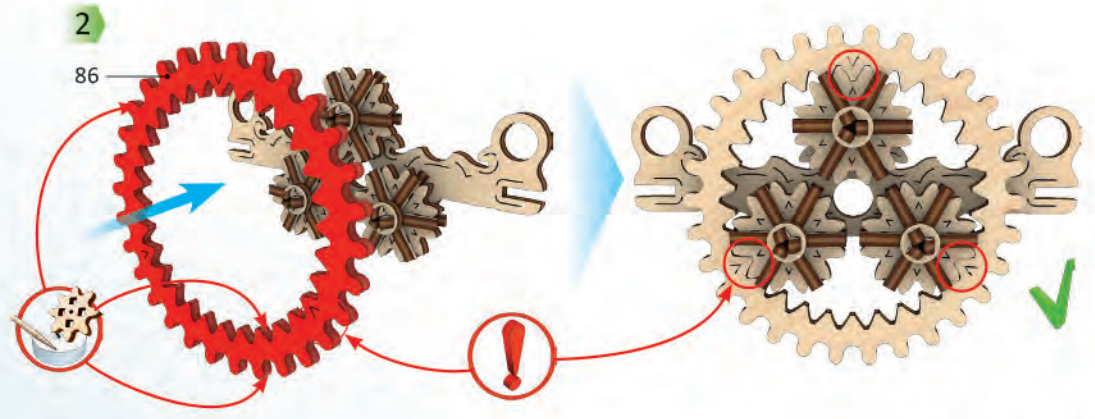
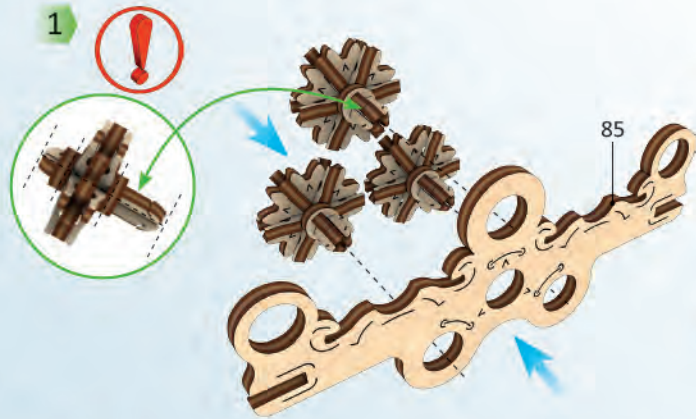
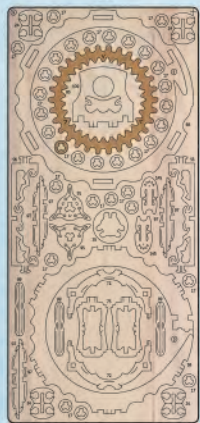
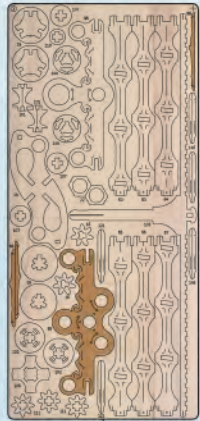



6

7

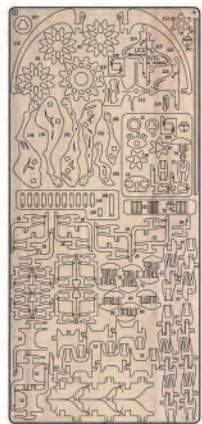

8

1

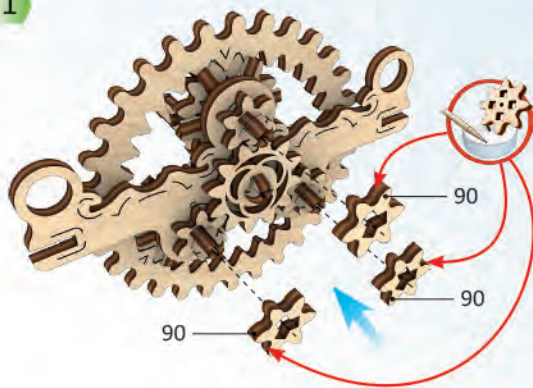

2

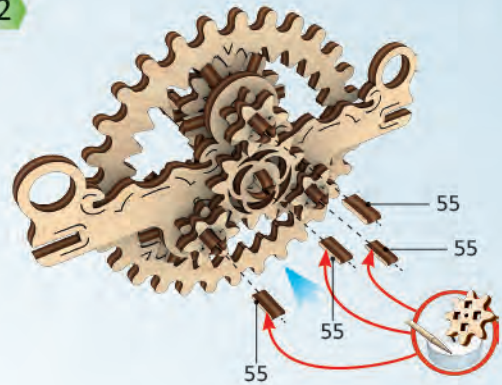

3

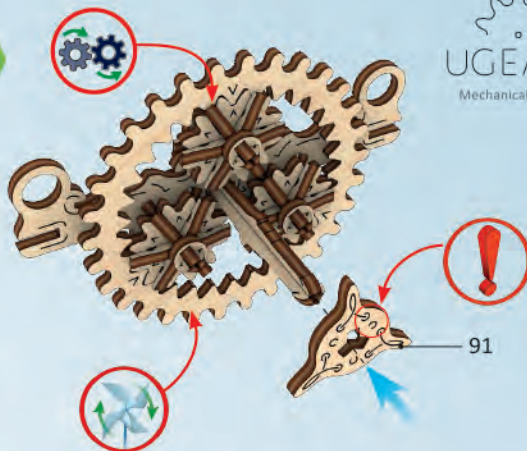

4

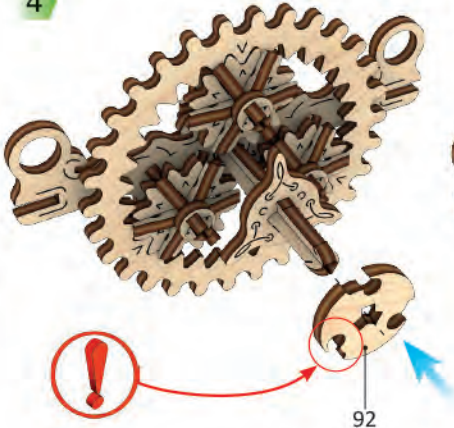

5

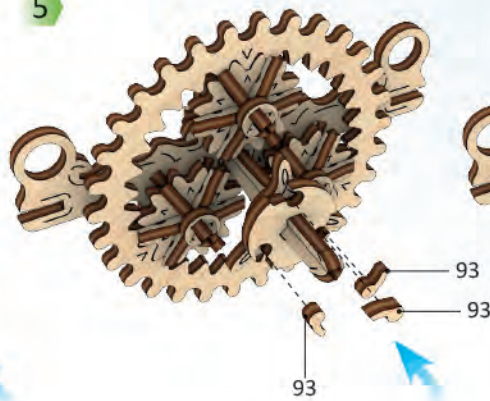

6

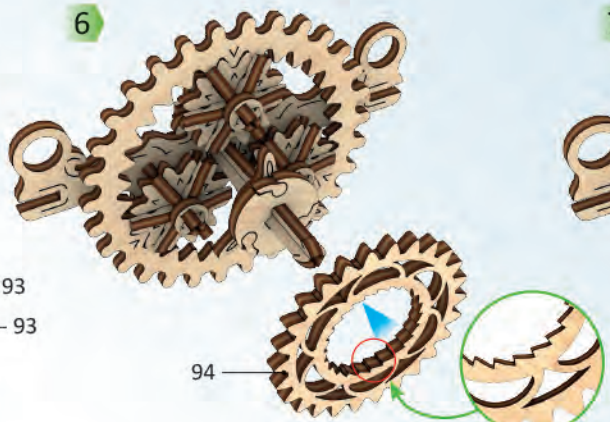

7

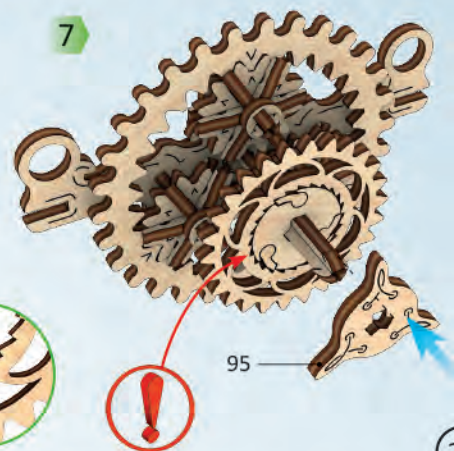

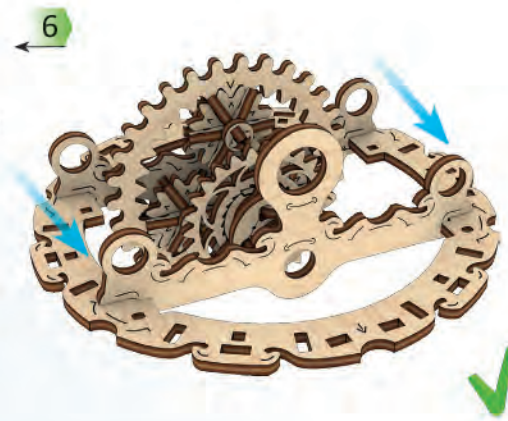
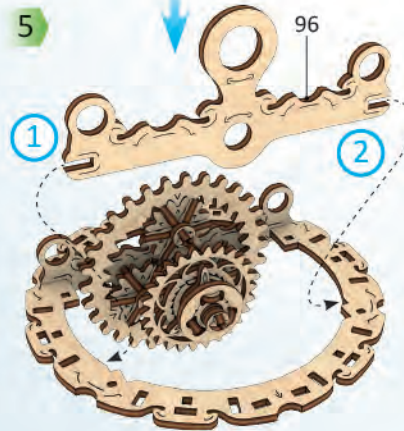
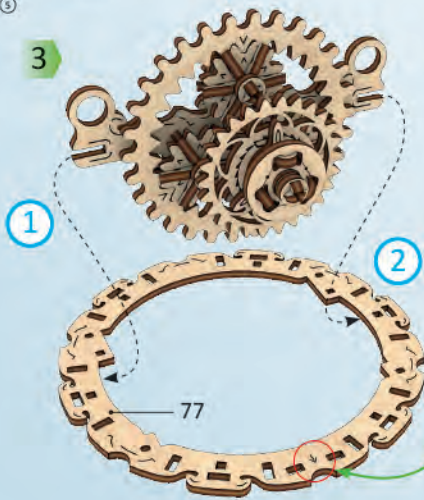
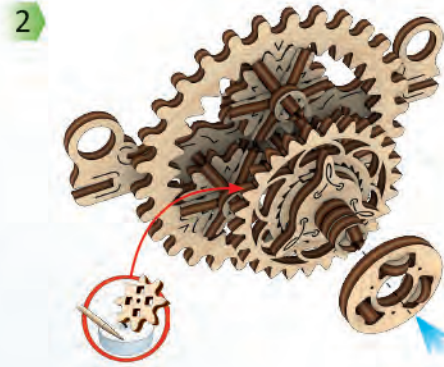
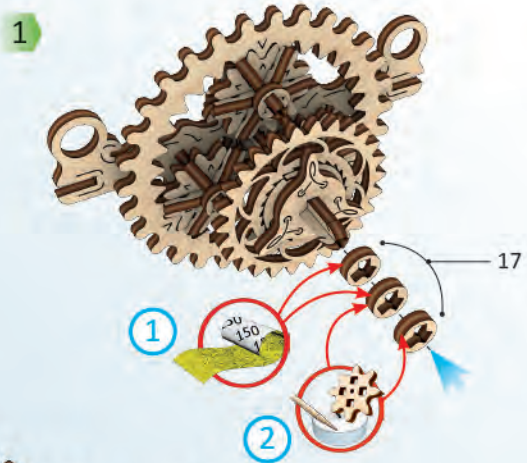
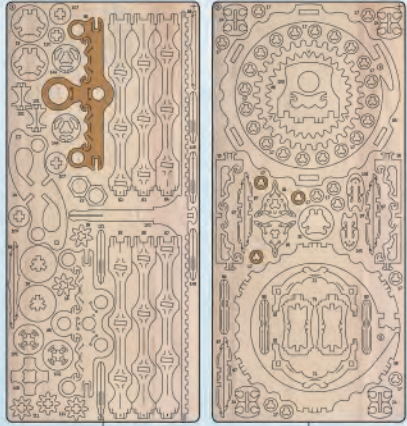

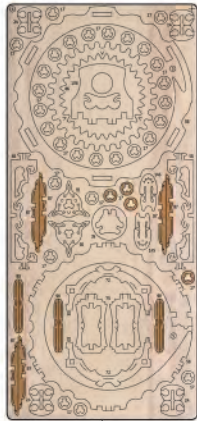

9



9

1

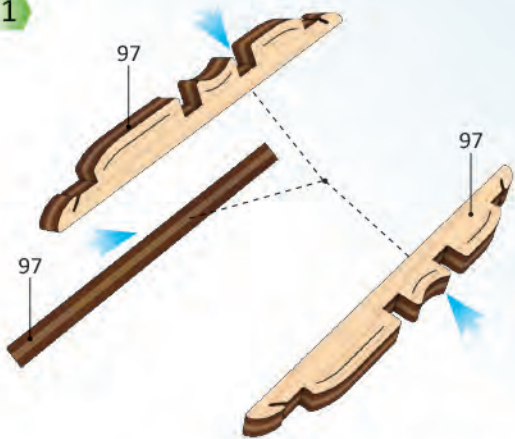

2

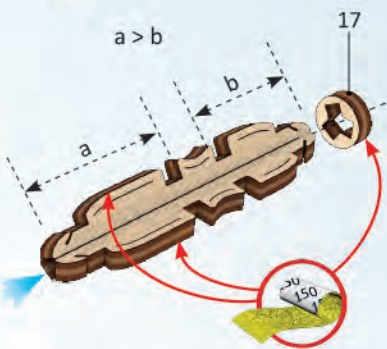

3



4



5

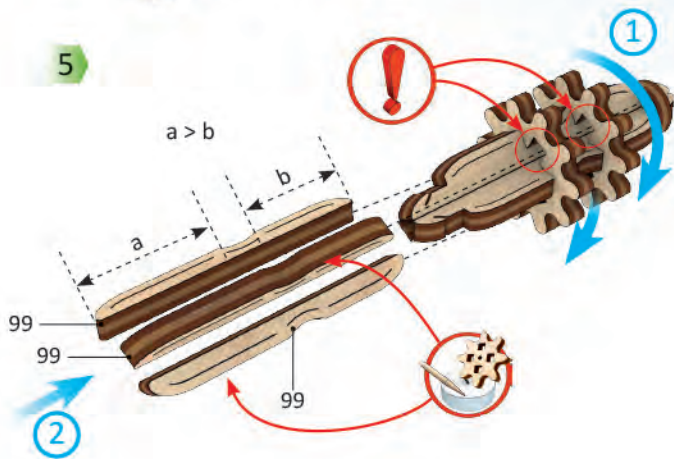

6

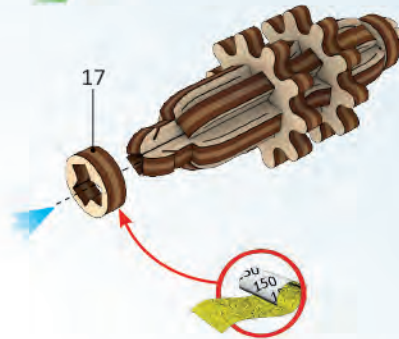

7

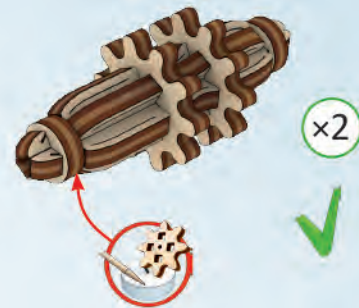

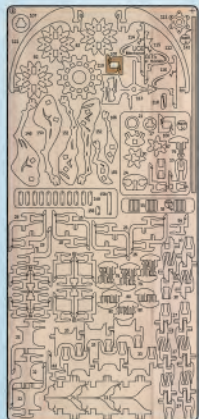
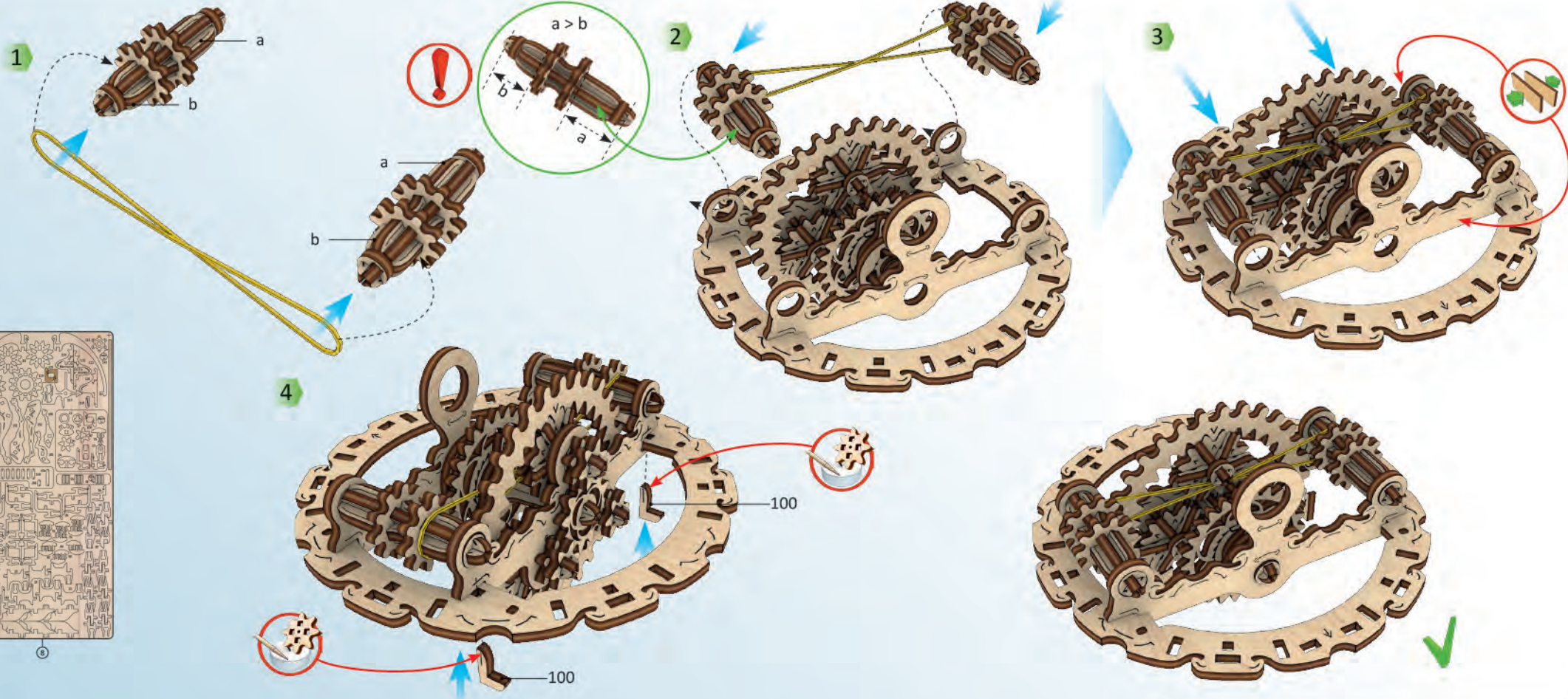

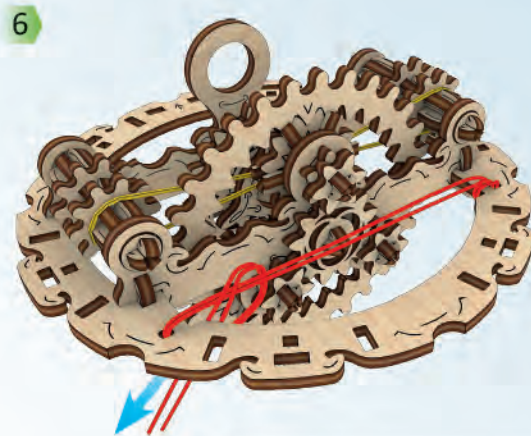
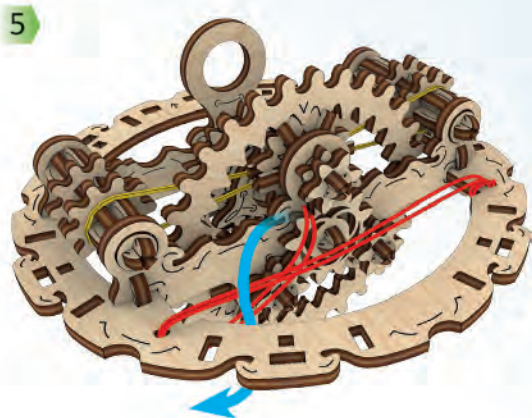
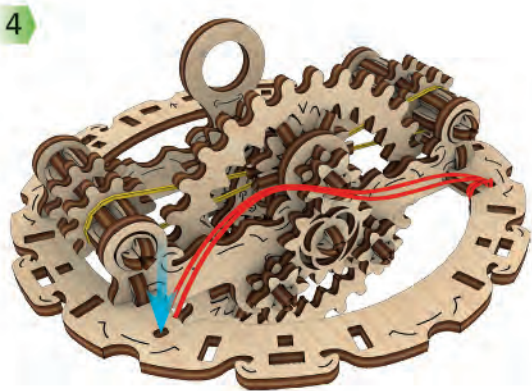
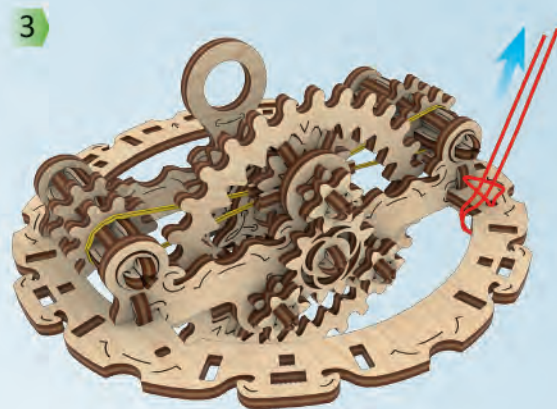
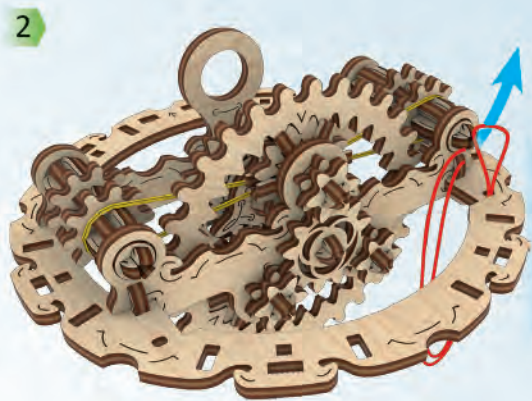
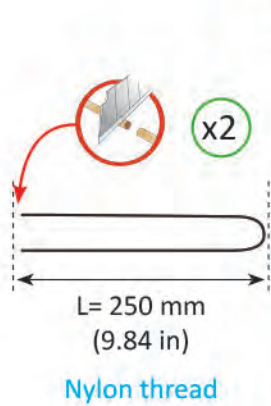

1

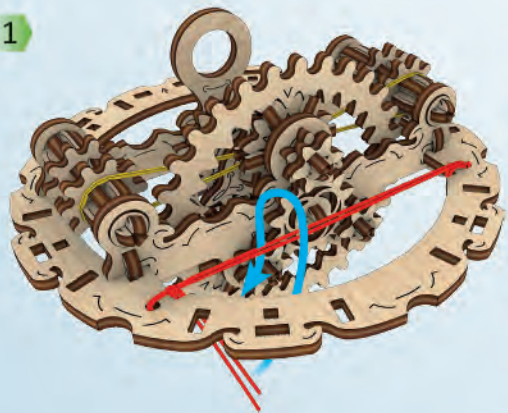

2

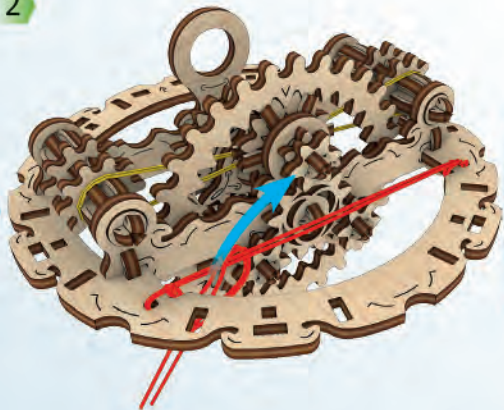

3

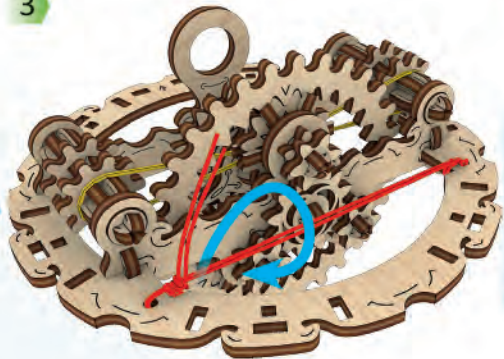

4

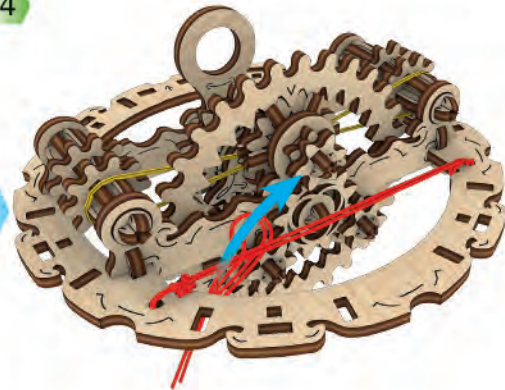

5

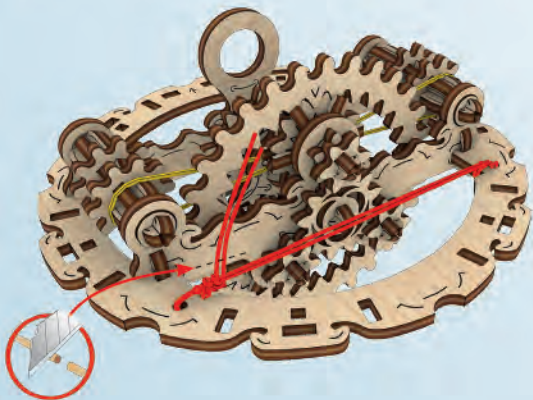

6

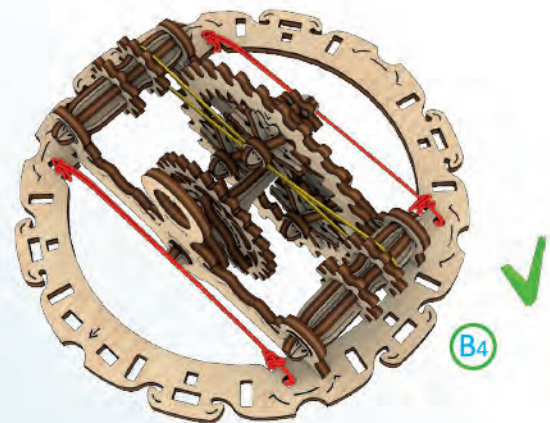
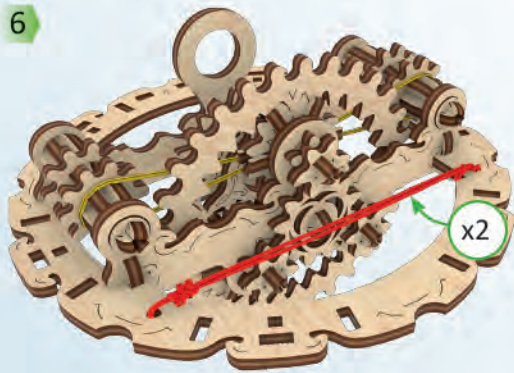



1

71

72

2

72

3

73

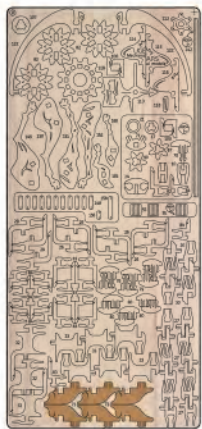

4

75

74

5

x6

6

76

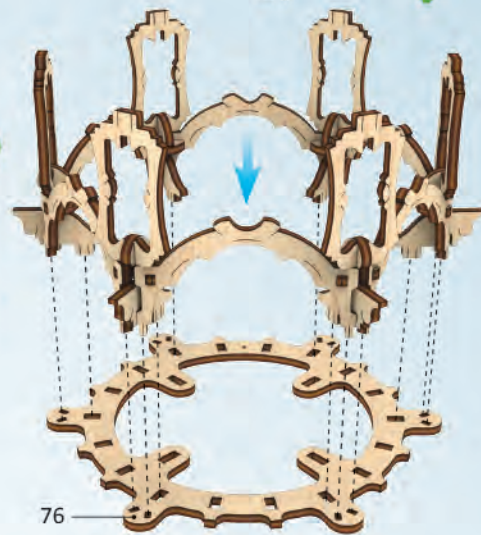
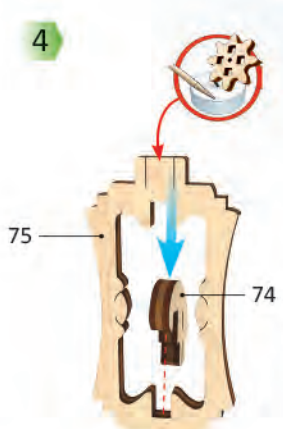

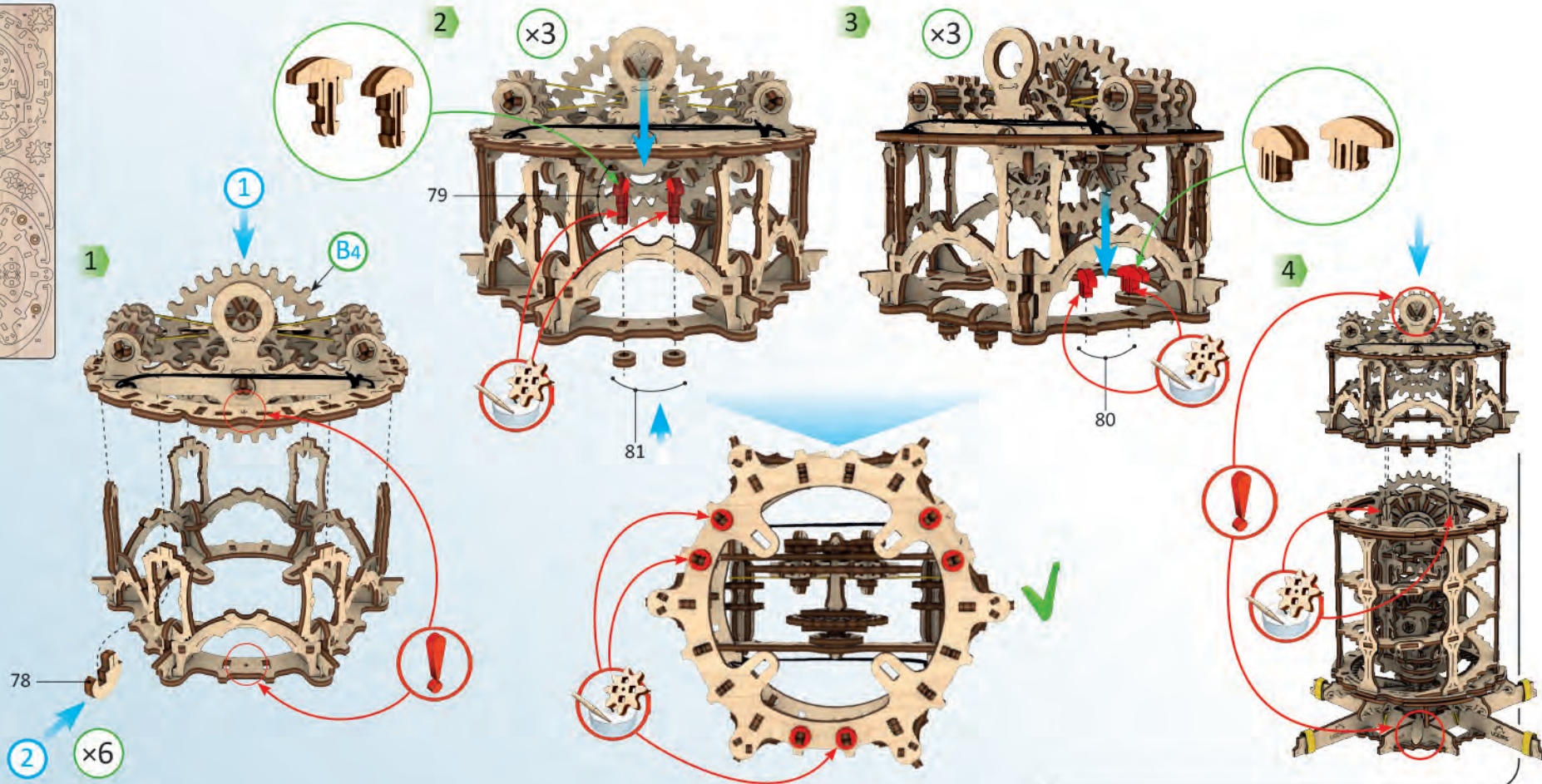

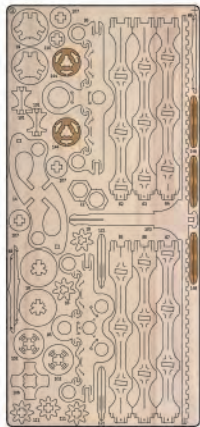

1

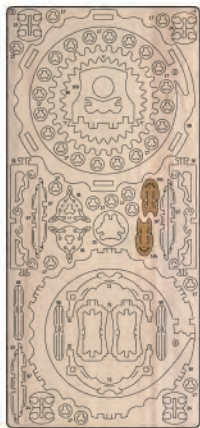

2

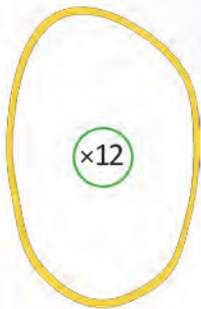

1

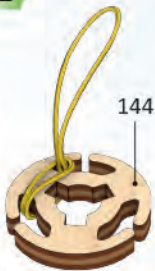

2



3



x3

4



145

x2



1

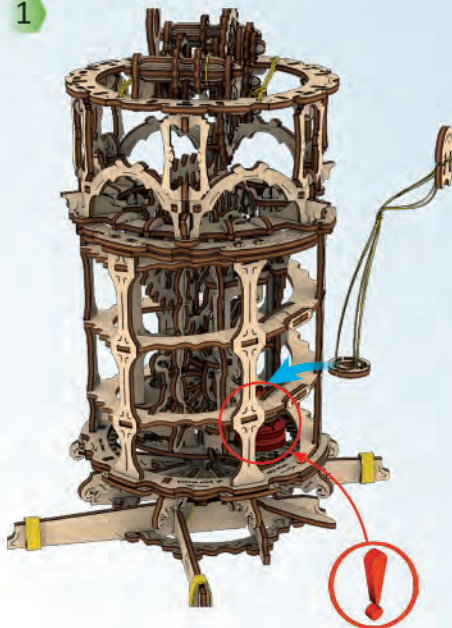

2

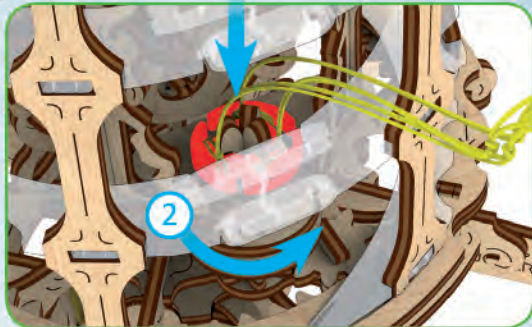

3



1

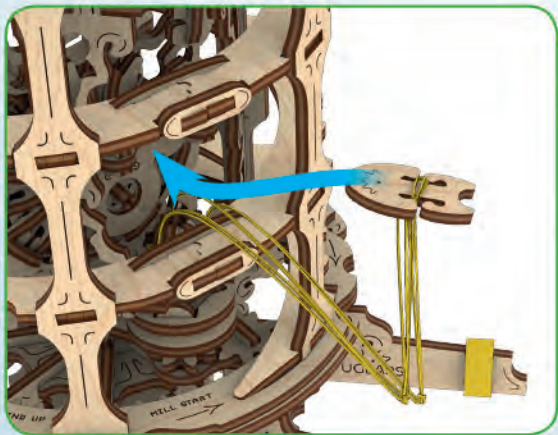

2

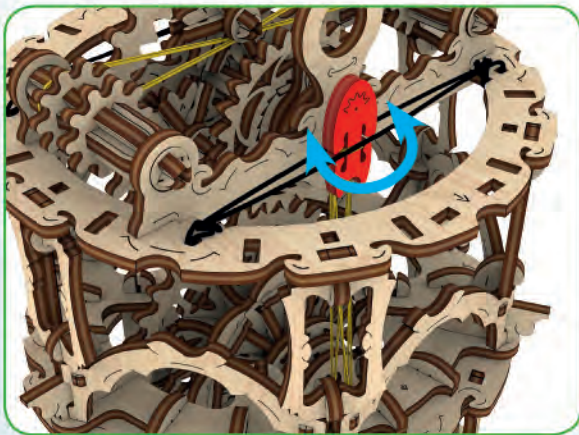

3

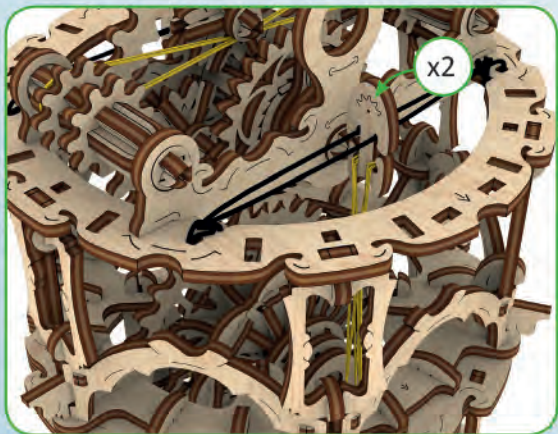

4

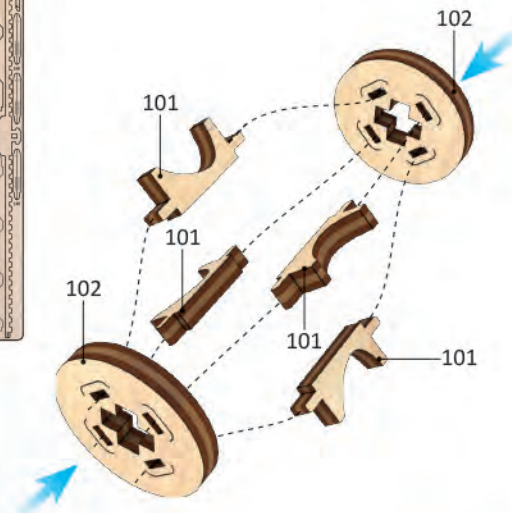
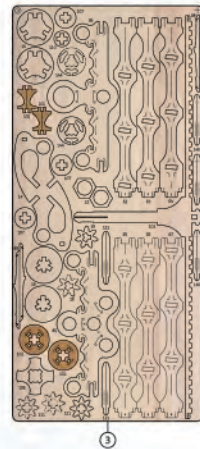
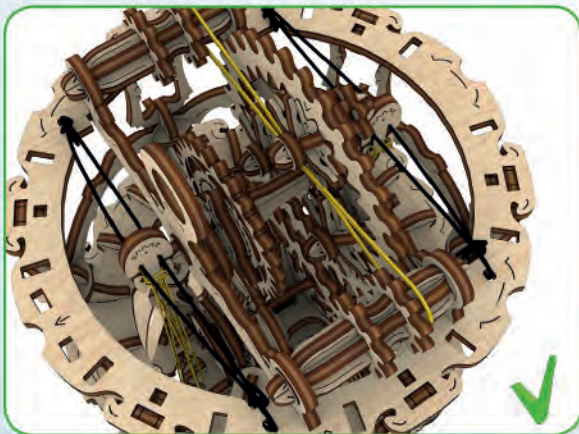

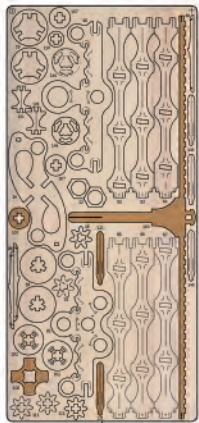

5

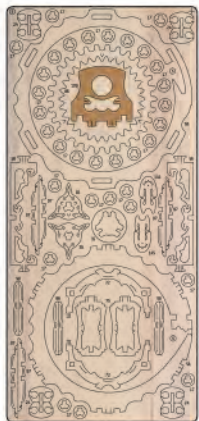

6



7



8

1

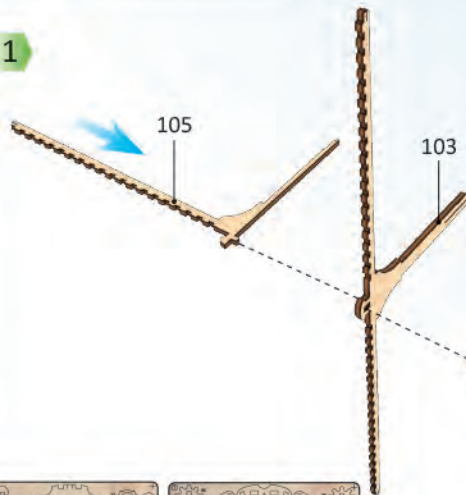

2

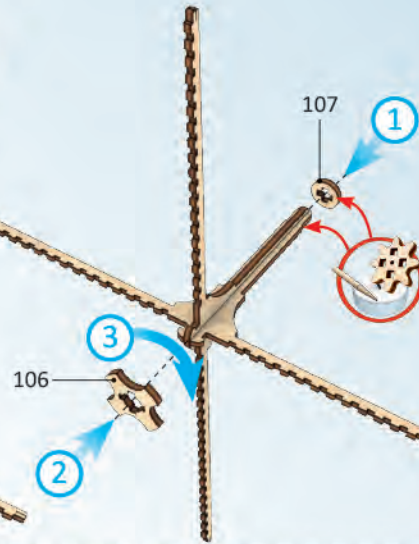

3

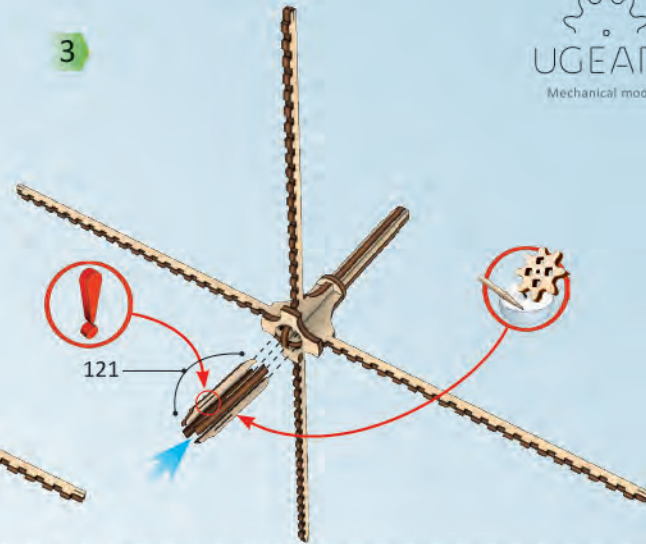

1

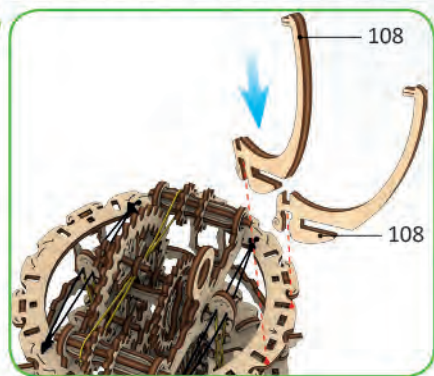

2

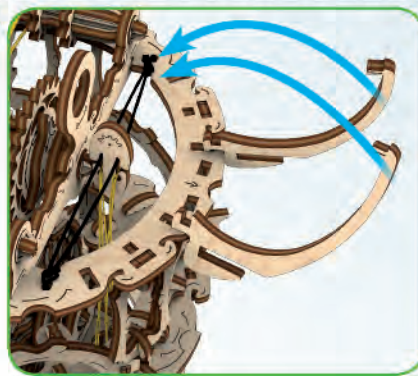

3

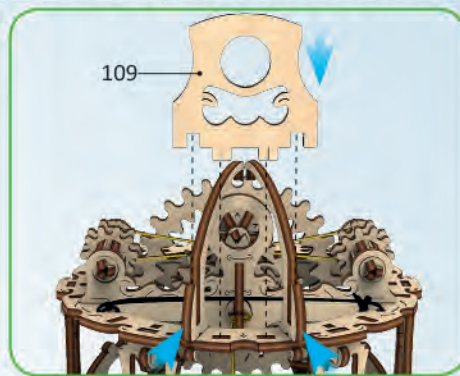

Mechanical models



1

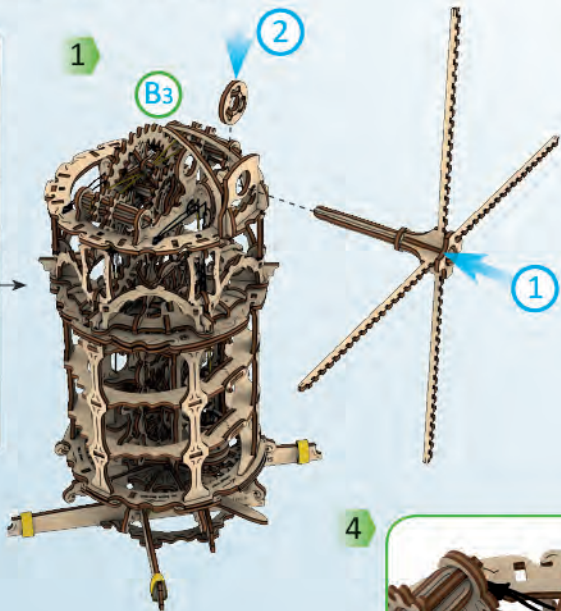

2

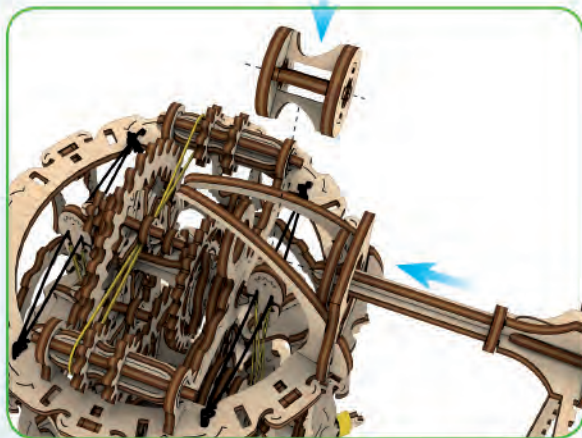

3

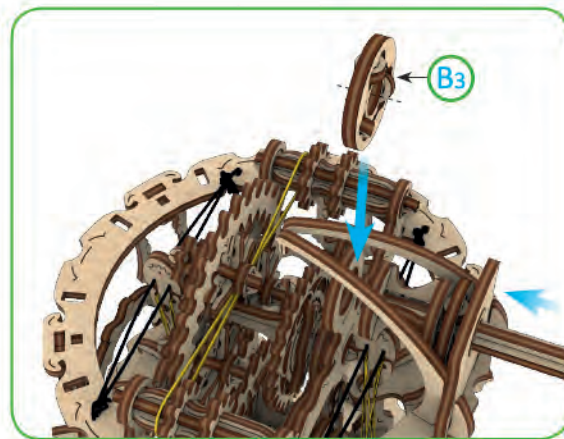

4

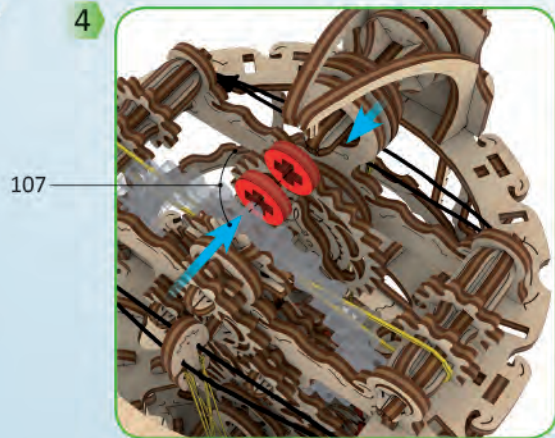

5



6

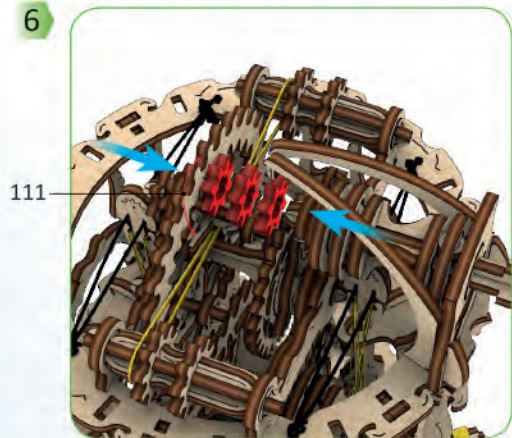

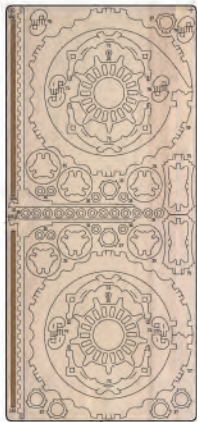

©



©

1

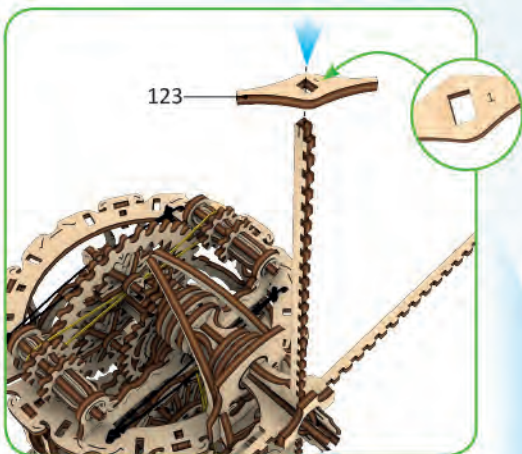

2

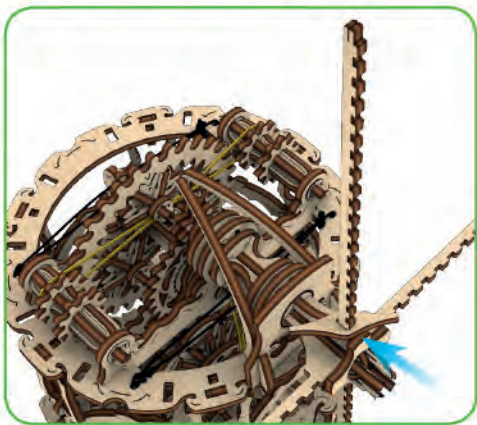

3

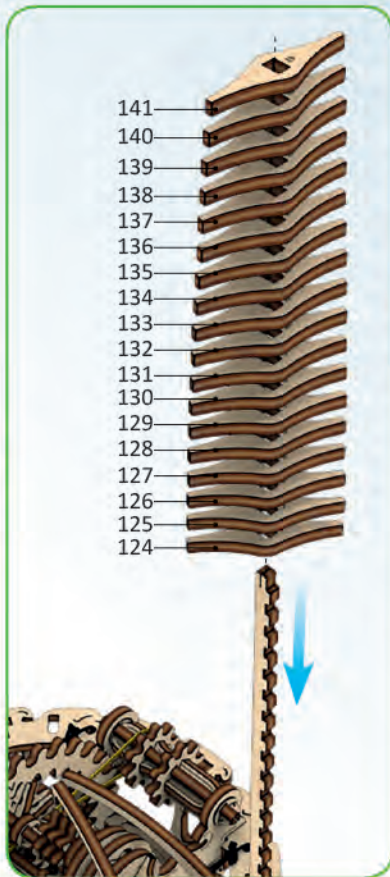

4

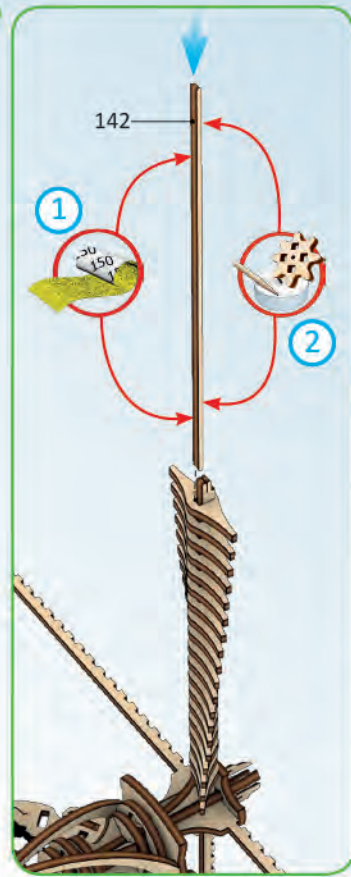

5

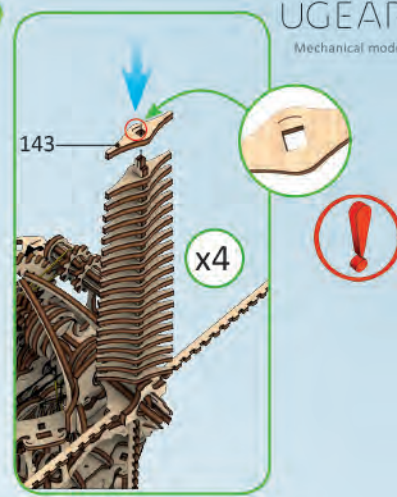

Mechanical models

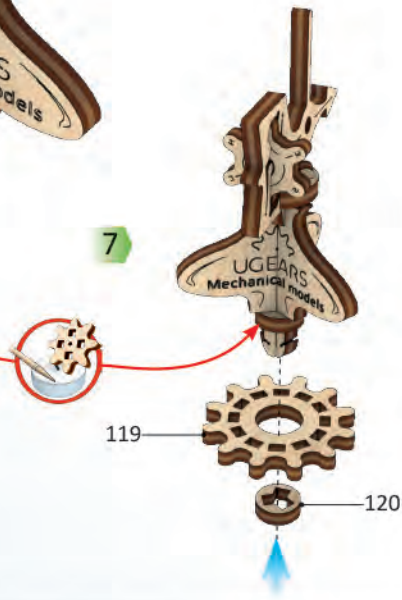
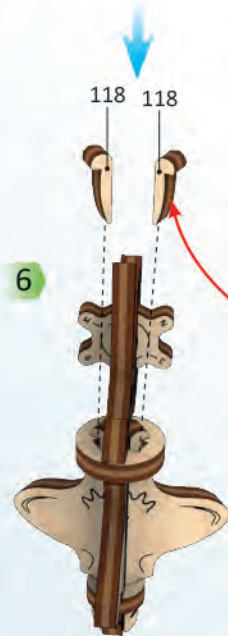
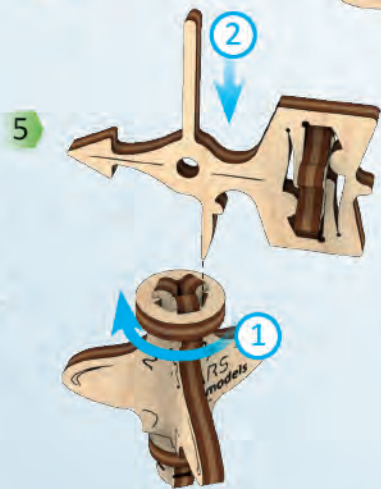
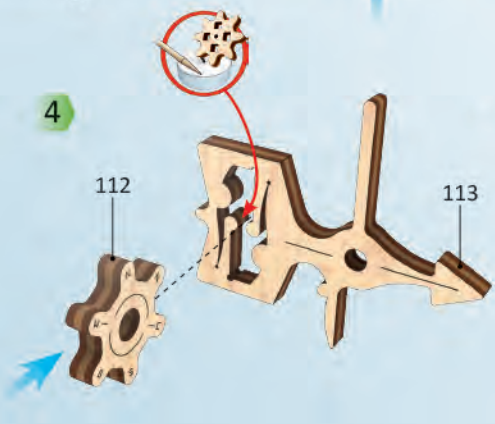
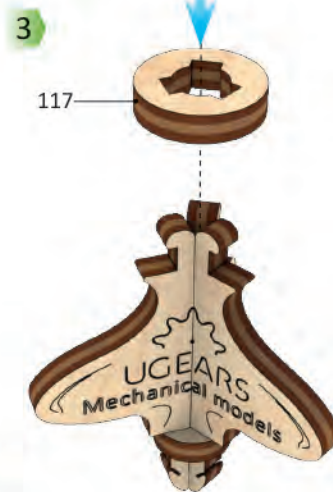
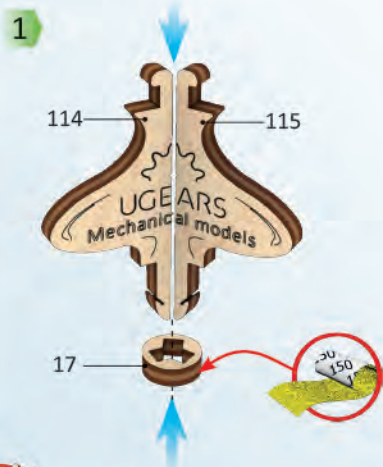
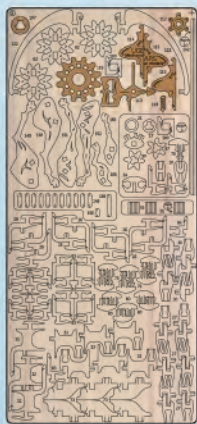
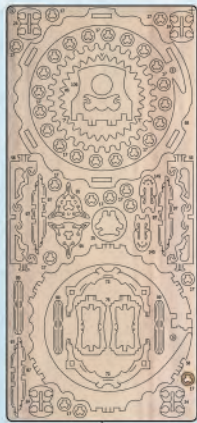



1

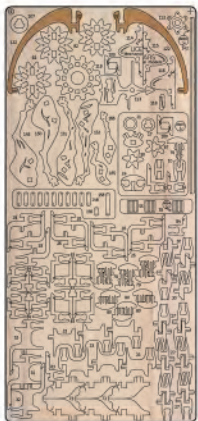
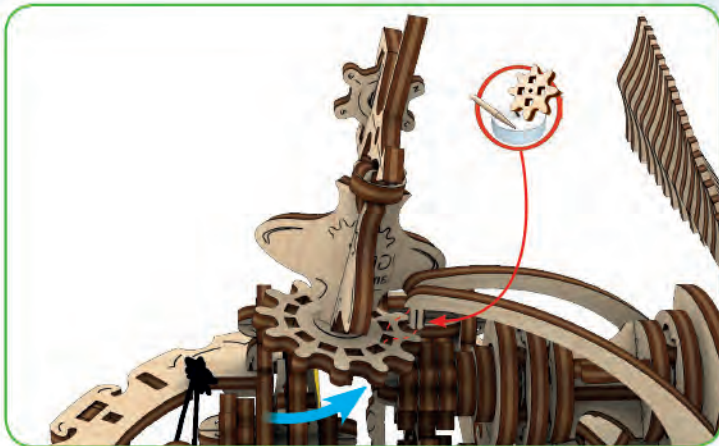

3

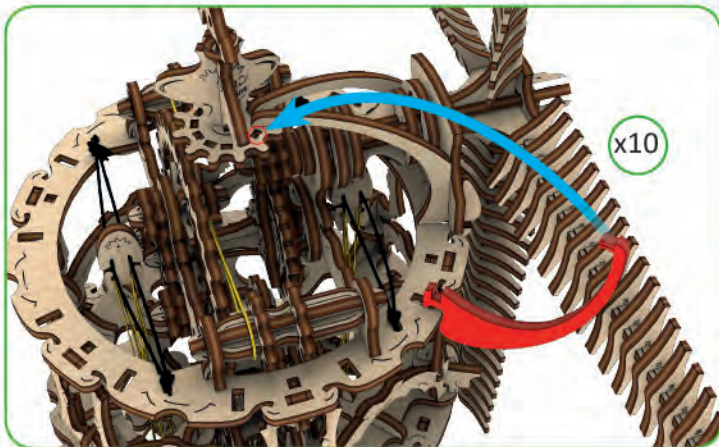

2

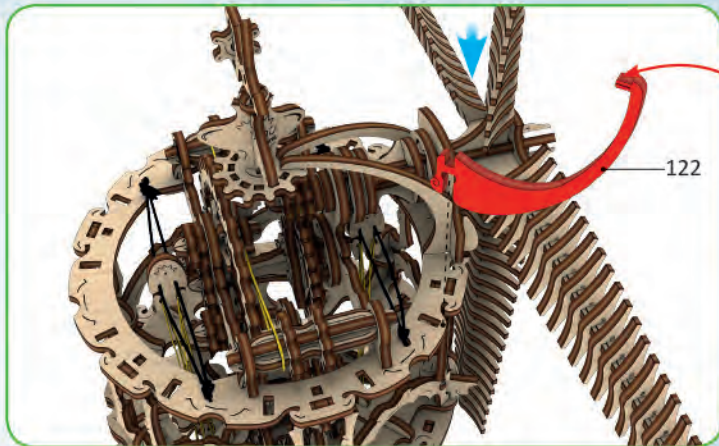

4

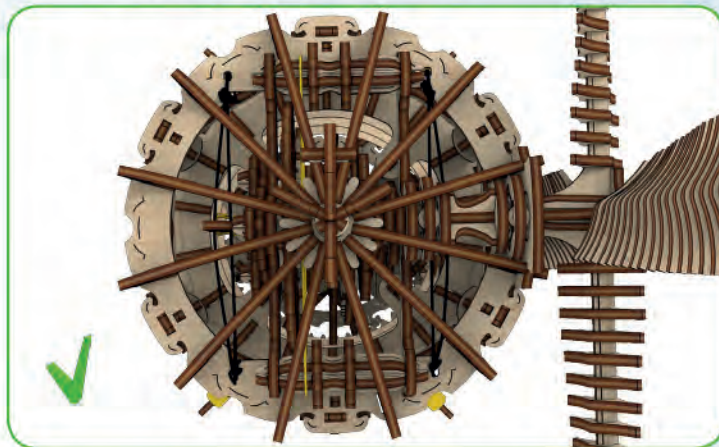

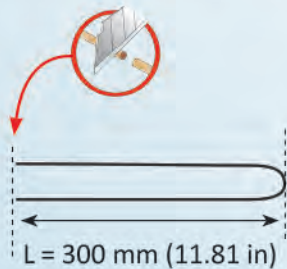

L = 300 mm (11.81 in)

Linen thread

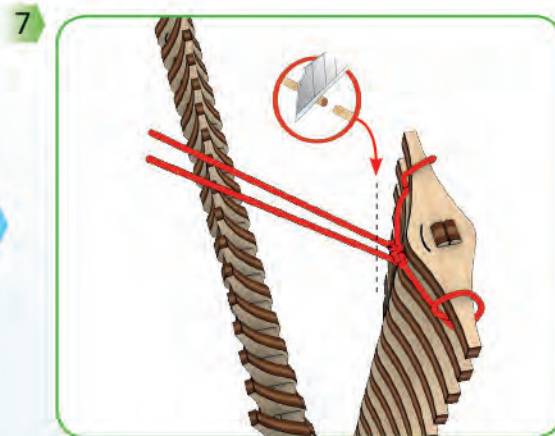
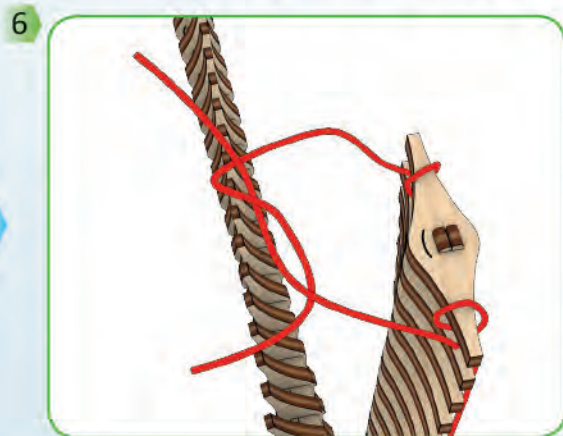
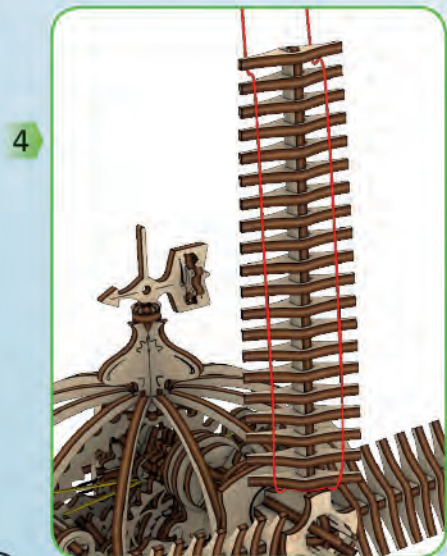
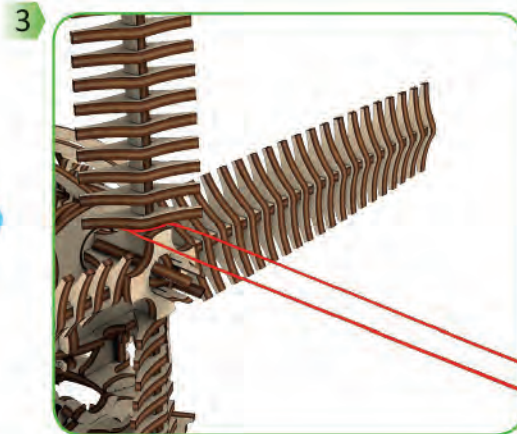
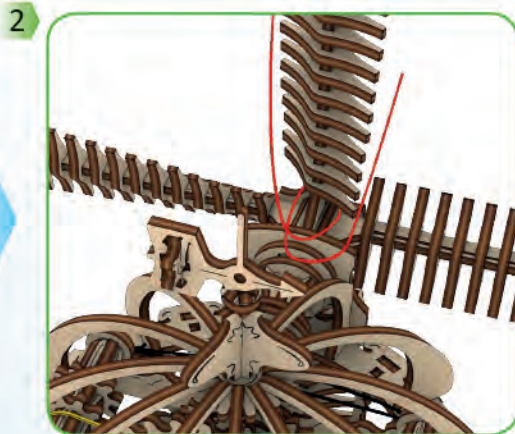
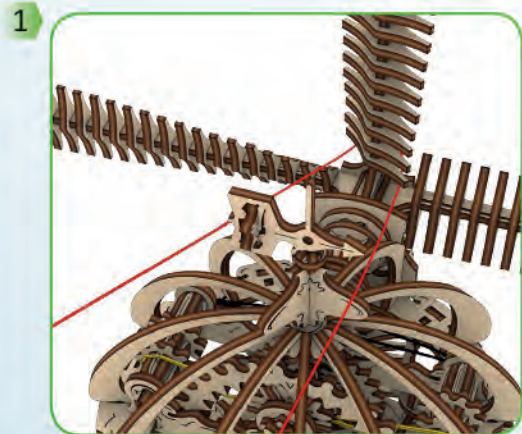



9

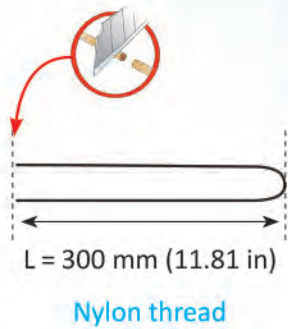

1

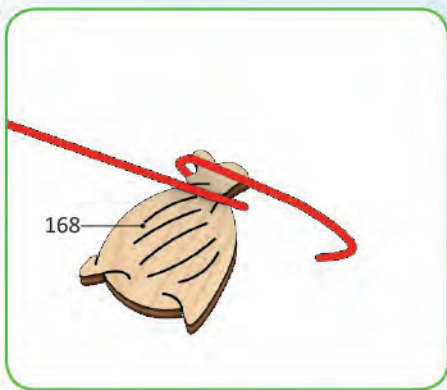

2



3

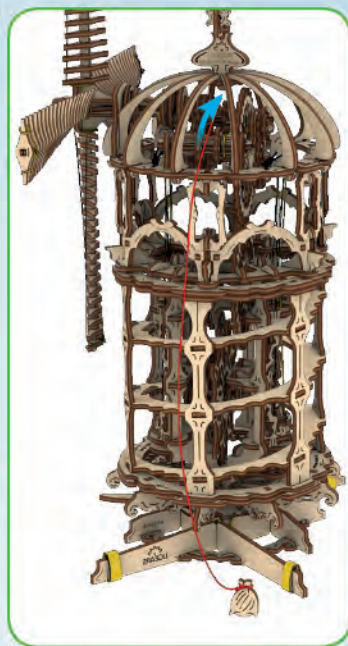

4

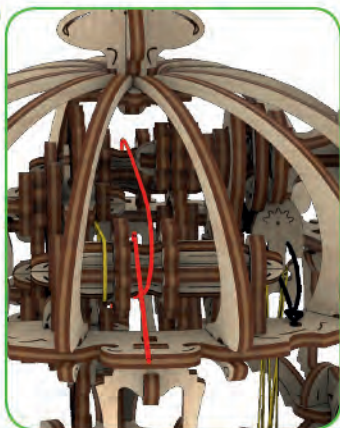

5



6

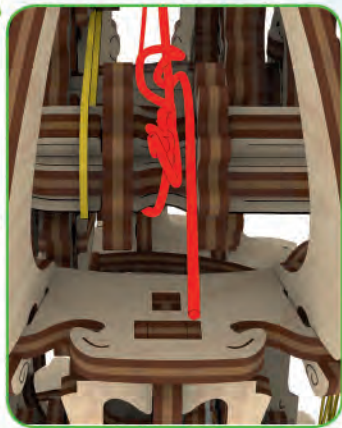

7





8

9

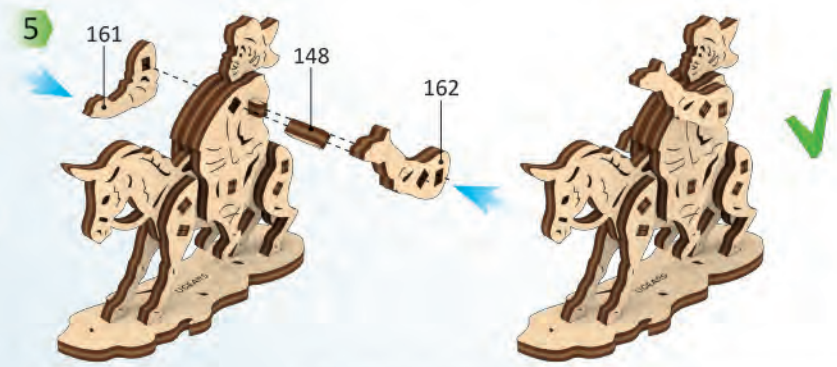
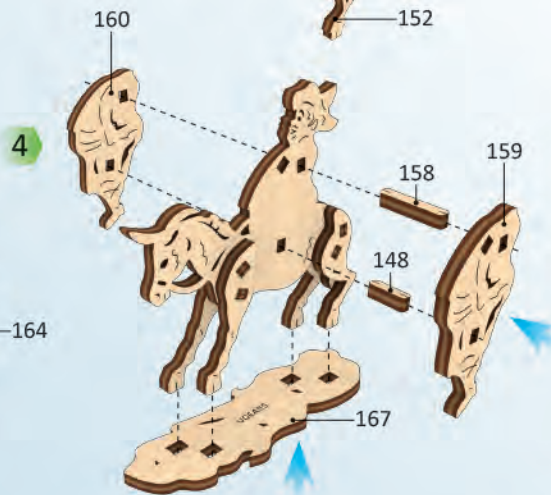
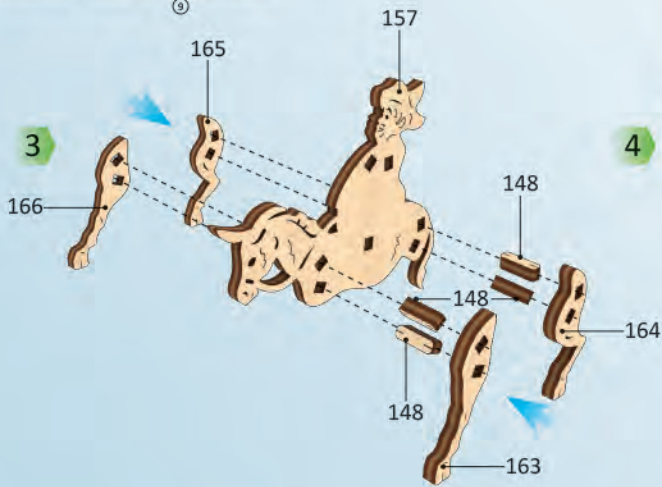
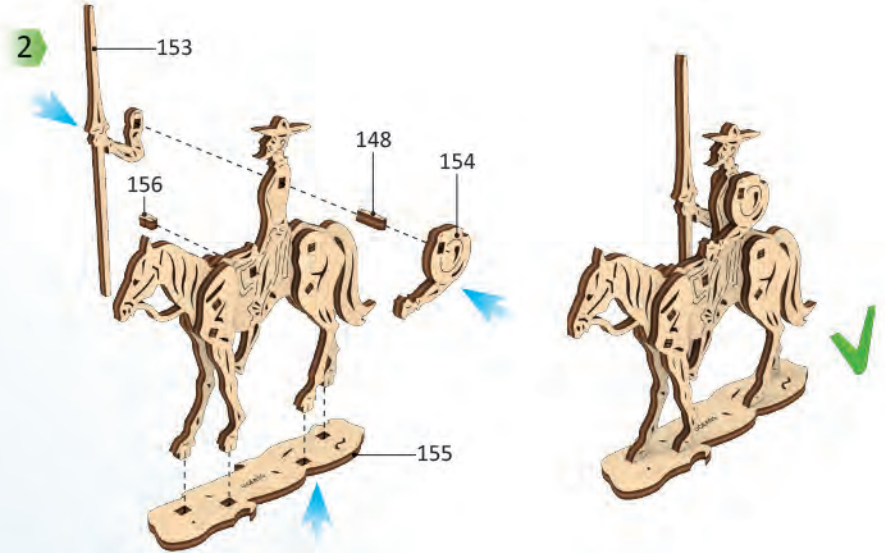
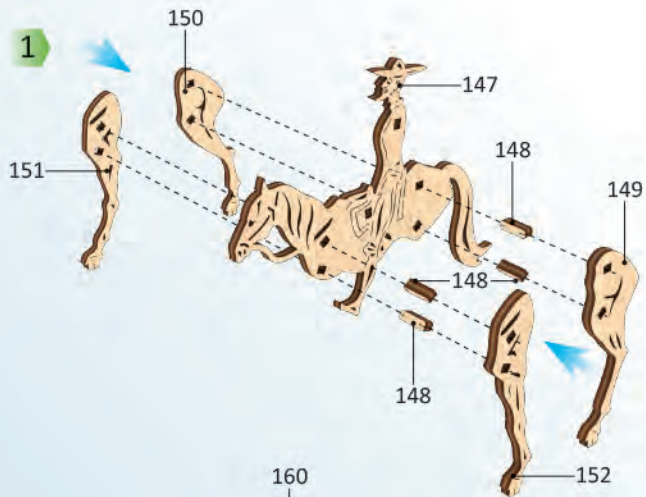

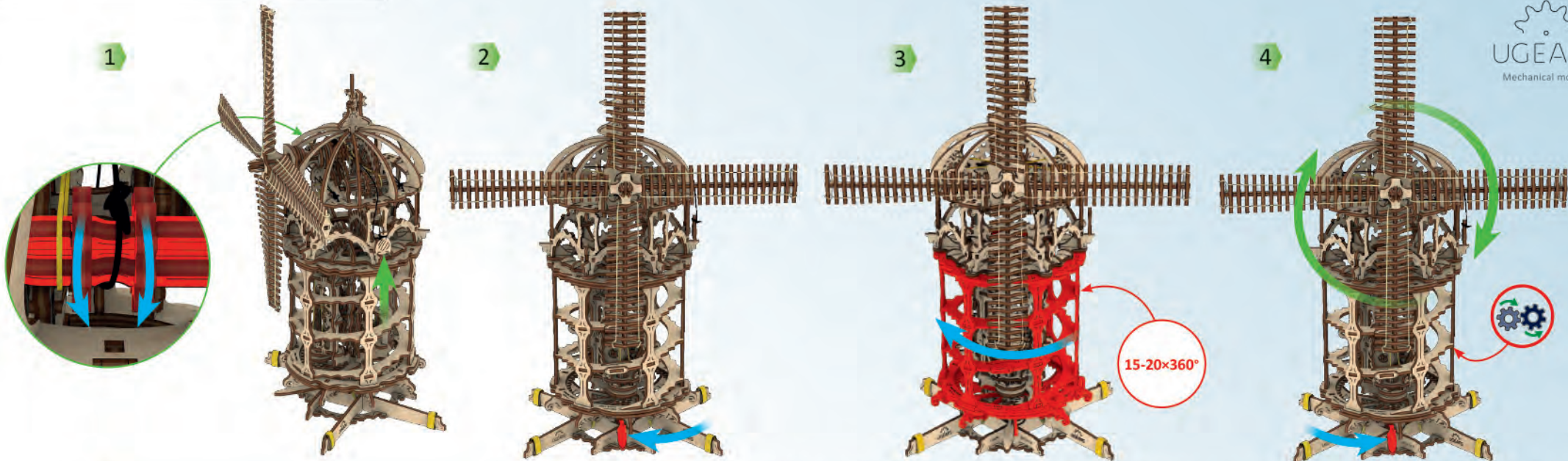

1



2



3





ENG Thanks for following along on this journey with us. **UKR** Дякуємо, що ви пройшли цей шлях з нами. **DEU** Vielen Dank, dass Sie diesen Weg mit uns gegangen sind. **FRA** Merci denous avoir accompagnés tout au long de ces étapes. **POL** Dziękujemy, że razem z nami pokonałeś tę drogę! **SPA** Gracias por haber recorrido el camino con nosotros. **ITA** Grazie per aver fatto uesto percorso con noi. **RUS** Спасибо, что вы прошли этот путь с нами. **JAP** UGEARSをご利用いただきありがとうございます。 **KOR** UGEARS 와 함께해 주셔서 감사합니다. **CHI** 感谢您参与有趣的模型拼装过程。

ugearsmodels.com



ENG Customer support **UKR** Служба підтримки **DEU** Kundendienst
FRA Service client **POL** Wsparcie klienta **SPA** Servicio al cliente
ITA Servizio di supporto **RUS** Служба поддержки
JAP お客様窓口 **KOR** 고객센터 **CHI** 客户支持

customerservice@ugearsmodels.com

Mechanical models